



Micro Commercial Components



Micro Commercial Components
20736 Marilla Street Chatsworth
CA91311
Phone: (818) 701-4933
Fax: (818) 701-4939

ESD3V3D3

3.3Volts
ESD Protection
Devices

Features

- Halogen free available upon request by adding suffix "-HF"
For sensitive ESD protection
Low clamping voltage
Low leakage
Protects one power or I/O port
ESD protection > 40 kV
Fast response ,response time less than 1ns.
Epoxy meets UL 94 V-0 flammability rating
Moisture Sensitivity Level 1

Maximum Ratings

- Operating Junction & Storage Temperature: -55°C to +150°C

Table with 5 columns: Parameter, Symbol, Limits, unit. Rows include IEC61000-4-2(ESD) Air Contact, ESD Voltage per human body mode, and Power Dissipation.

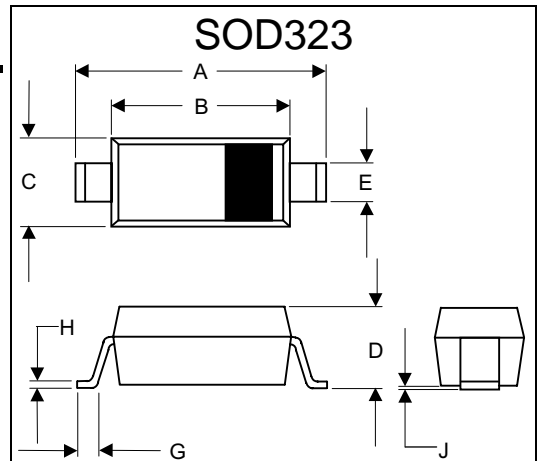

DIMENSIONS table with columns: DIM, INCHES (MIN, MAX), MM (MIN, MAX), NOTE. Rows A through J.

SUGGESTED SOLDER PAD LAYOUT

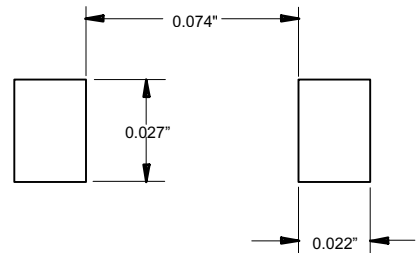

ELECTRICAL CHARACTERISTICS ($T_A = 25^\circ\text{C}$ unless otherwise noted)

Symbol	Parameter
I_{PP}	Maximum Reverse Peak Pulse Current
V_C	Clamping Voltage @ I_{PP}
V_{RWM}	Working Peak Reverse Voltage
I_R	Maximum Reverse Leakage Current @ V_{RWM}
V_{BR}	Breakdown Voltage @ I_T
I_T	Test Current
I_F	Forward Current
V_F	Forward Voltage @ I_F
P_{pk}	Peak Power Dissipation
C	Max. Capacitance @ $V_R=0$ and $f=1\text{MHz}$

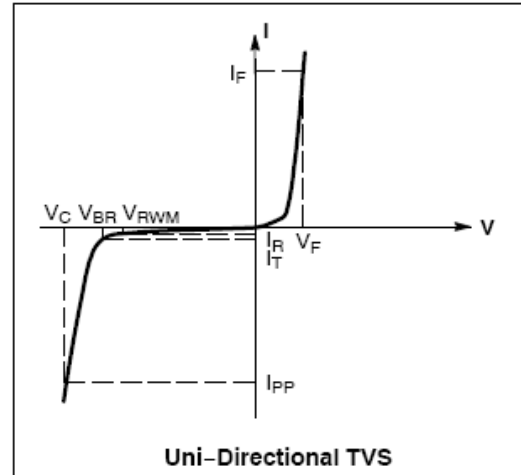

ELECTRICAL CHARACTERISTICS ($T_A = 25^\circ\text{C}$ unless otherwise noted)

Device	Device Marking	V_{RWM}	I_R (μA)	V_{BR} (V)		I_T	V_C	Cj(pF)
		(V)	@ V_{RWM}	@ I_T (Note 2)	Min			
		Max	Max			mA	@ $I_{PP} = 7\text{A}$	$V_R=0\text{V}$
							V	Typ
ESD3V3D3	---	3.3	1.0	5.0	---	1.0	9.3	100

TYPICAL CHARACTERISTICS

**FIGURE 1
PEAK PULSE POWER VS PULSE TIME**

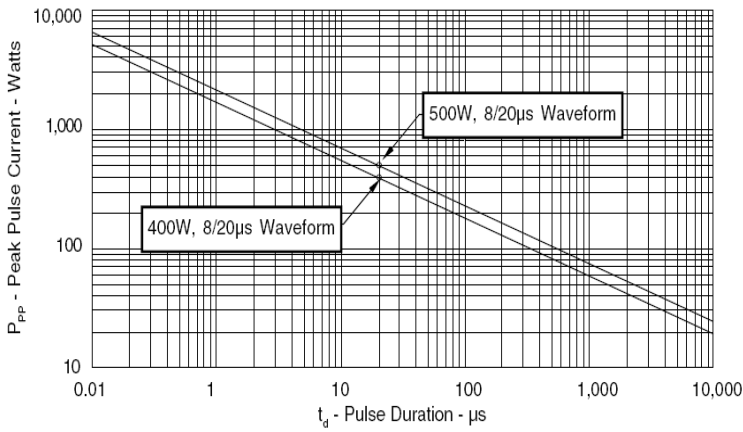

**FIGURE 2
PULSE WAVE FORM**

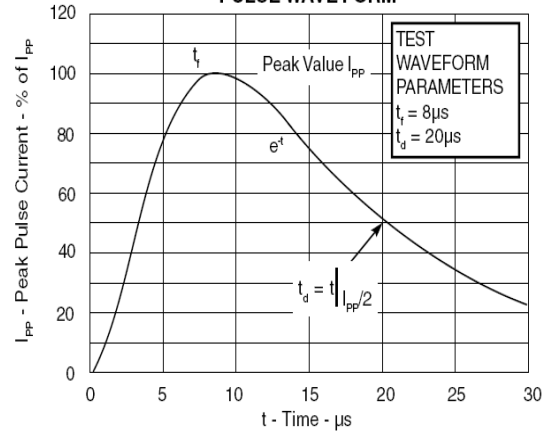

**FIGURE 3
POWER DERATING CURVE**

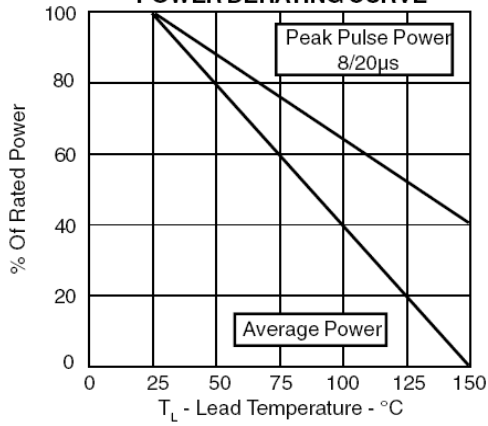

**FIGURE 4
TYPICAL REVERSE VOLTAGE VS CAPACITANCE**

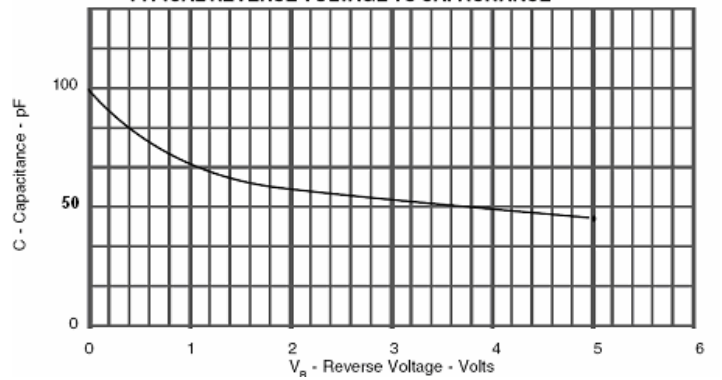



Micro Commercial Components

Ordering Information :

Device	Packing
Part Number-TP	Tape&Reel: 3Kpcs/Reel

Note : Adding "-HF" suffix for halogen free, eg. Part Number-TP-HF

IMPORTANT NOTICE

Micro Commercial Components Corp. reserves the right to make changes without further notice to any product herein to make corrections, modifications , enhancements , improvements , or other changes . Micro Commercial Components Corp . does not assume any liability arising out of the application or use of any product described herein; neither does it convey any license under its patent rights ,nor the rights of others . The user of products in such applications shall assume all risks of such use and will agree to hold Micro Commercial Components Corp . and all the companies whose products are represented on our website, harmless against all damages.

LIFE SUPPORT

MCC's products are not authorized for use as critical components in life support devices or systems without the express written approval of Micro Commercial Components Corporation.

CUSTOMER AWARENESS

Counterfeiting of semiconductor parts is a growing problem in the industry. Micro Commercial Components (MCC) is taking strong measures to protect ourselves and our customers from the proliferation of counterfeit parts. MCC strongly encourages customers to purchase MCC parts either directly from MCC or from Authorized MCC Distributors who are listed by country on our web page cited below. Products customers buy either from MCC directly or from Authorized MCC Distributors are genuine parts, have full traceability, meet MCC's quality standards for handling and storage. MCC will not provide any warranty coverage or other assistance for parts bought from Unauthorized Sources. MCC is committed to combat this global problem and encourage our customers to do their part in stopping this practice by buying direct or from authorized distributors.