

SMBJ5925BHE3 THRU SMBJ5956BHE3

1.5 Watt Surface Mount Silicon Zener Diodes

DO-214AA (SMB) (LEAD FRAME)

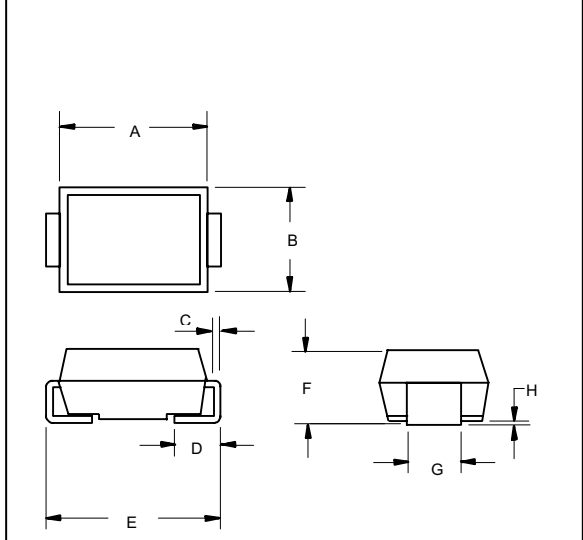

DIM	INCHES		MM		NOTE
	MIN	MAX	MIN	MAX	
A	.160	.185	4.06	4.70	
B	.130	.155	3.30	3.94	
C	.006	.012	0.15	0.31	
D	.030	.060	0.76	1.52	
E	.200	.220	5.08	5.59	
F	.079	.096	2.00	2.44	
G	.075	.087	1.91	2.21	
H	.002	.008	0.05	0.203	

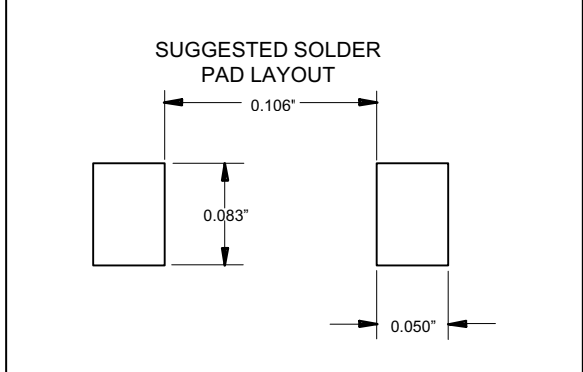

Features

- Halogen free
- AEC-Q101 Qualified
- Surface Mount Application
- 10V thru 200 Volt Voltage Range
- Low Inductance, Low Profile Mounting
- Glass Passivated Junction
- Lead Free Finish/Rohs Compliant (Note1) ("P" Suffix designates Compliant. See ordering information)

Mechanical Data

- CASE: JEDEC DO-214AA molded Surface Mountable
- Terminals solderable per MIL-STD-750, Method 2026
- Polarity is indicated by cathode band.
- Packaging: Standard 12mm Tape (see EIA 481)
- Maximum temperature for soldering: 260°C for 10 seconds.
- Epoxy meets UL 94 V-0 flammability rating
- Moisture Sensitivity Level 1

Maximum Ratings @ 25°C Unless Otherwise Specified

Output Current	I _F	200mA	
Maximum Forward Voltage	V _F	1.5V	(Note: 2)
Steady State Power Dissipation	P _(AV)	1.5W	(Note: 3)
Operation And Storage Temperature	T _J , T _{STG}	-55°C to +150 °C	

- NOTES:**
1. High Temperature Solder Exemptions Applied, see EU Directive Annex 7.
 2. Forward Current @ 200mA.
 3. Mounted on 5.0mm² (1oz thick) land areas.
Lead temperature at T_L=75°C

SMBJ5925BHE3 THRU SMBJ5956BHE3

ELECTRICAL CHARACTERISTICS(TL=30 centigrade unless otherwise noted) (VF=1.5Volts Max @IF=200mAdc for all types.

MCC PART NUMBER	ZENER VOLTAGE V_Z (*)	TEST CURRENT I_{ZT}	MAXIMUM DYNAMIC IMPEDANCE $Z_{ZT} @ I_{ZT}$	KNEE CURRENT I_{ZK}	KNEE IMPEDANCE Z_{ZK}	MAXIMUM REVERSE CURRENT I_R	REVERSE VOLTAGE V_R	DEVICE MARKING
	VOLTS	mA	OHMS	mA	OHMS	μ A	VOLTS	
SMBJ5925BHE3	10	37.5	4.5	0.25	500	5.0	8.0	925B
SMBJ5926BHE3	11	34.1	5.5	0.25	550	1.0	8.4	926B
SMBJ5927BHE3	12	31.2	6.5	0.25	550	1.0	9.1	927B
SMBJ5928BHE3	13	28.8	7.0	0.25	550	1.0	9.9	928B
SMBJ5929BHE3	15	25.0	9.0	0.25	600	1.0	11.4	929B
SMBJ5930BHE3	16	23.4	10.0	0.25	600	1.0	12.2	930B
SMBJ5931BHE3	18	20.8	12.0	0.25	650	1.0	13.7	931B
SMBJ5932BHE3	20	18.7	14.0	0.25	650	1.0	15.2	932B
SMBJ5933BHE3	22	17.0	17.5	0.25	650	1.0	16.7	933B
SMBJ5934BHE3	24	15.6	19.0	0.25	700	1.0	18.2	934B
SMBJ5935BHE3	27	13.9	23.0	0.25	700	1.0	20.6	935B
SMBJ5936BHE3	30	12.5	28.0	0.25	750	1.0	22.8	936B
SMBJ5937BHE3	33	11.4	33.0	0.25	800	1.0	25.1	937B
SMBJ5938BHE3	36	10.4	38.0	0.25	850	1.0	27.4	938B
SMBJ5939BHE3	39	9.6	45.0	0.25	900	1.0	29.7	939B
SMBJ5940BHE3	43	8.7	53.0	0.25	950	1.0	32.7	940B
SMBJ5941BHE3	47	8.0	67.0	0.25	1000	1.0	35.8	941B
SMBJ5942BHE3	51	7.3	70.0	0.25	1100	1.0	38.8	942B
SMBJ5943BHE3	56	6.7	86.0	0.25	1300	1.0	42.6	943B
SMBJ5944BHE3	62	6.0	100	0.25	1500	1.0	47.1	944B
SMBJ5945BHE3	68	5.5	120	0.25	1700	1.0	51.2	945B
SMBJ5946BHE3	75	5.0	140	0.25	2000	1.0	56.0	946B
SMBJ5947BHE3	82	4.6	160	0.25	2500	1.0	62.2	947B
SMBJ5948BHE3	91	4.1	200	0.25	3000	1.0	69.2	948B
SMBJ5949BHE3	100	3.7	250	0.25	3100	1.0	76.0	949B
SMBJ5950BHE3	110	3.4	300	0.25	4000	1.0	83.6	950B
SMBJ5951BHE3	120	3.1	380	0.25	4500	1.0	91.2	951B
SMBJ5952BHE3	130	2.9	450	0.25	5000	1.0	98.8	952B
SMBJ5953BHE3	150	2.5	600	0.25	6000	1.0	114	953B
SMBJ5954BHE3	160	2.3	700	0.25	6500	1.0	121.6	954B
SMBJ5955BHE3	180	2.1	900	0.25	7000	1.0	136.8	955B
SMBJ5956BHE3	200	1.9	1200	0.25	8000	1.0	152	956B

* TOLERANCE AND VOLTAGE DESIGNATION Tolerance designation - The type numbers listed indicate a tolerance of +/-5%

RATING AND CHARACTERISTICS CURVES
SMBJ5925BHE3 THRU SMBJ5956BHE3

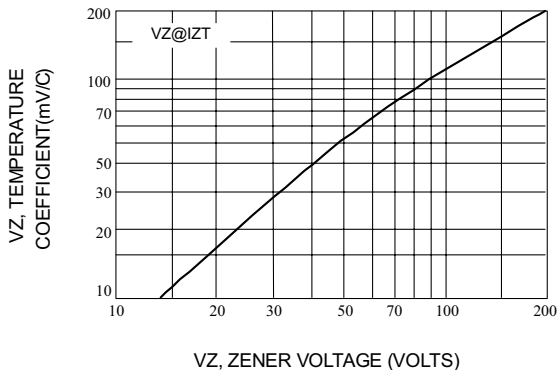

Fig. 1-ZENER VOLTAGE-10 TO 200 VOLTS

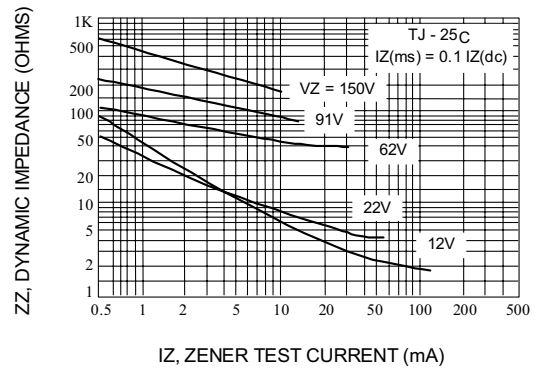

Fig. 2-EFFECT OF ZENER CURRENT

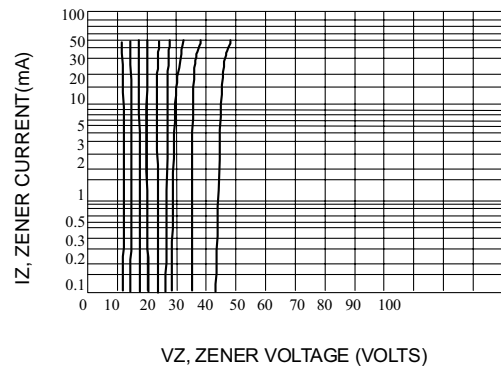
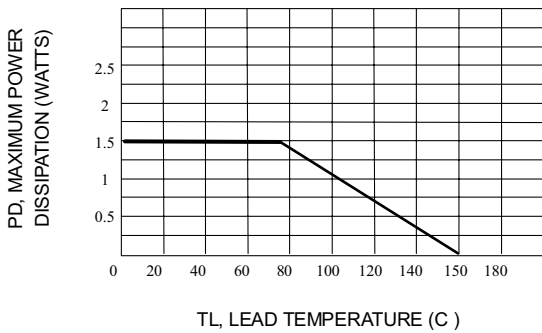
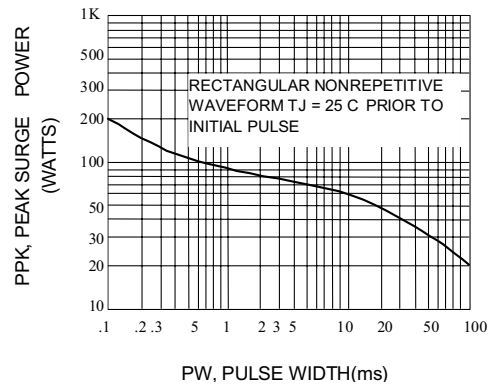
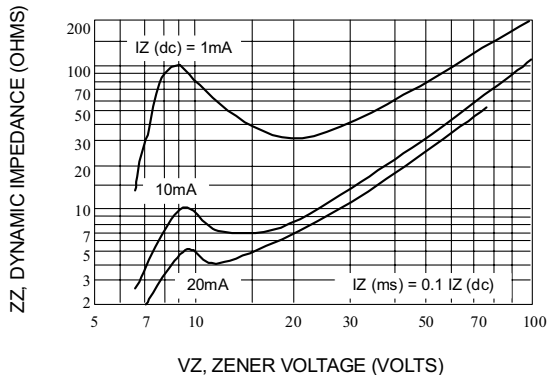

Fig. 5-STEADY STATE POWER DERATING

Fig. 6-VZ = 12 THRU 40 VOLTS

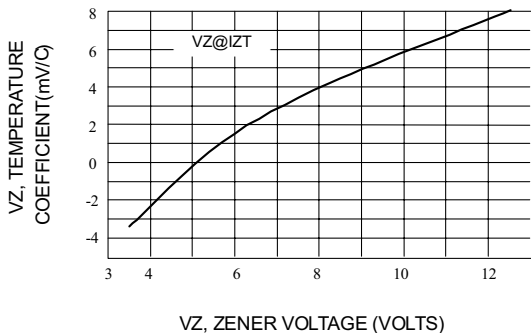

Fig. 7-ZENER VOLTAGE-TO 12 VOLTS



Micro Commercial Components

Ordering Information :

Device	Packing
Part Number-TP	Tape&Reel: 3Kpcs/Reel

*****IMPORTANT NOTICE*****

Micro Commercial Components Corp. reserves the right to make changes without further notice to any product herein to make corrections, modifications , enhancements , improvements , or other changes . **Micro Commercial Components Corp .** does not assume any liability arising out of the application or use of any product described herein; neither does it convey any license under its patent rights ,nor the rights of others . The user of products in such applications shall assume all risks of such use and will agree to hold **Micro Commercial Components Corp .** and all the companies whose products are represented on our website, harmless against all damages.

*****LIFE SUPPORT*****

MCC's products are not authorized for use as critical components in life support devices or systems without the express written approval of Micro Commercial Components Corporation.

*****CUSTOMER AWARENESS*****

Counterfeiting of semiconductor parts is a growing problem in the industry. Micro Commercial Components (MCC) is taking strong measures to protect ourselves and our customers from the proliferation of counterfeit parts. MCC strongly encourages customers to purchase MCC parts either directly from MCC or from Authorized MCC Distributors who are listed by country on our web page cited below. Products customers buy either from MCC directly or from Authorized MCC Distributors are genuine parts, have full traceability, meet MCC's quality standards for handling and storage. **MCC will not provide any warranty coverage or other assistance for parts bought from Unauthorized Sources.** MCC is committed to combat this global problem and encourage our customers to do their part in stopping this practice by buying direct or from authorized distributors.