

### Features

- Ultrafast Reverse Recovery Time
- Low Reverse Recovery Loss
- Low Forward Voltage
- High Surge Current Capability
- Popular SOT-227 Package

### Applications

- Inversion Welder
- Uninterruptible Power Supply (UPS)
- Plating Power Supply
- Ultrasonic Cleaner and Welder
- Power Factor Correction (PFC) Circuit
- Converter & Chopper



**120 Amp  
FRED Modules  
600 Volts**

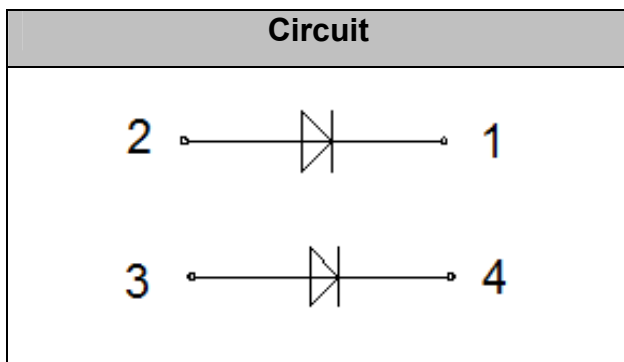
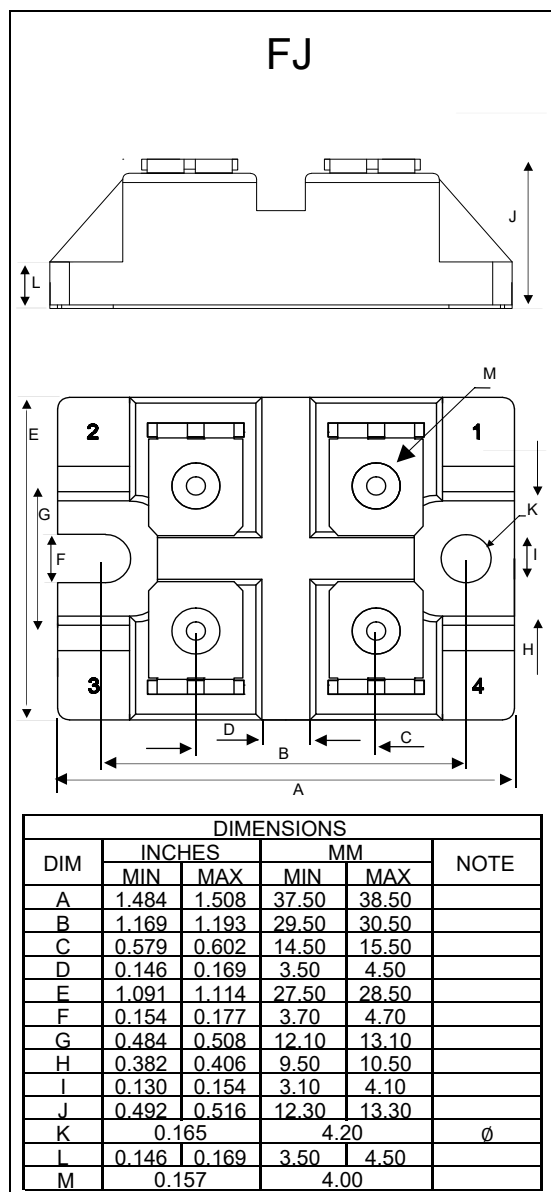

### Maximum Ratings

Symbol	Conditions	Values	Units
$V_R$		600	V
$V_{RRM}$		600	V
$I_{F(AV)}$	$T_C=90^\circ\text{C}$ , Per Leg	60	A
	$T_C=90^\circ\text{C}$ , Per Moudle	120	A
	$T_C=90^\circ\text{C}$ , 20KHz, Per Moudle	80	A
$I_{F(RMS)}$	$T_C=90^\circ\text{C}$ , Per Leg	85	A
$I_{FSM}$	1/2 Cycle , 50Hz, Sine	550	A
	1/2 Cycle , 60Hz, Sine	600	A
$I^2t$	$T_J=45^\circ\text{C}$ , $t=10\text{ms}$ , 50Hz, Sine	1510	$\text{A}^2\text{s}$
	$T_J=45^\circ\text{C}$ , $t=8.3\text{ms}$ , 60Hz, Sine	1490	$\text{A}^2\text{s}$
$P_D$	$T_C=25^\circ\text{C}$	208	W
$T_J$		-40 to +150	$^\circ\text{C}$
$T_{STG}$		-40 to +125	$^\circ\text{C}$
Visol	3600V AC 1s	1	mA
Torque	To Sink Recommended (M4)	0.7~1.5	N·m
Torque	To Terminal Recommended (M4)	0.7~1.1	N·m
Weight		27	g

### Thermal Characteristics

Symbol	Conditions	Values	Units
$R_{th(j-c)}$	Per diode	0.6	$^\circ\text{C/W}$

### Electrical Characteristics

Symbol	Conditions	Values			Units
		Min.	Typ.	Max.	
$I_{RM}$	$V_R=600\text{V}$	--	--	0.1	mA
	$V_R=600\text{V}$ , $T_J=125^\circ\text{C}$	--	--	1	mA
$V_F$	$I_F=60\text{A}$	--	1.55	1.9	V
	$I_F=60\text{A}$ , $T_J=125^\circ\text{C}$	--	1.35	1.7	V
trr	$I_F=1\text{A}$ , $V_R=30\text{V}$ , $di_F/dt=-200\text{A}/\mu\text{s}$	--	35	50	ns
trr	$V_R=300\text{V}$ , $I_F=60\text{A}$ , $di_F/dt=-200\text{A}/\mu\text{s}$ , $T_J=25^\circ\text{C}$	--	75	--	ns
$I_{RRM}$		--	7.2	--	A
trr	$V_R=300\text{V}$ , $I_F=60\text{A}$ , $di_F/dt=-200\text{A}/\mu\text{s}$ , $T_J=125^\circ\text{C}$	--	135	--	ns
$I_{RRM}$		--	16	--	A

**Performance Curves**

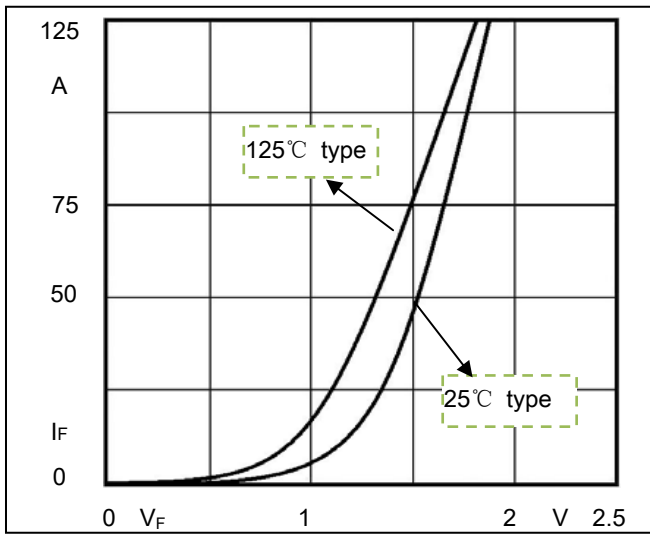

**Fig1. Forward Voltage Drop vs Forward Current**

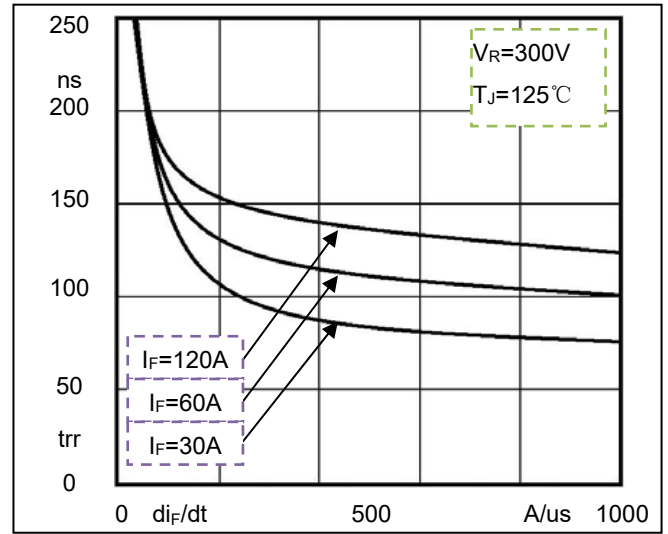

**Fig2. Reverse Recovery Time vs diF/dt**

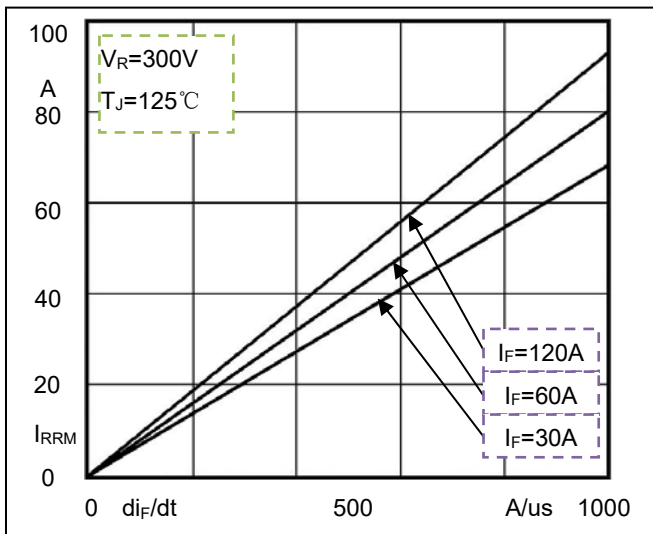

**Fig3. Reverse Recovery Current vs diF/dt**

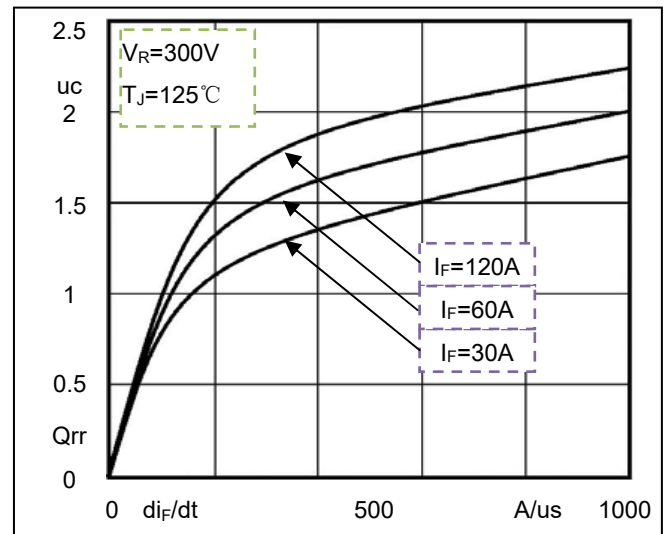

**Fig4. Reverse Recovery Charge vs diF/dt**

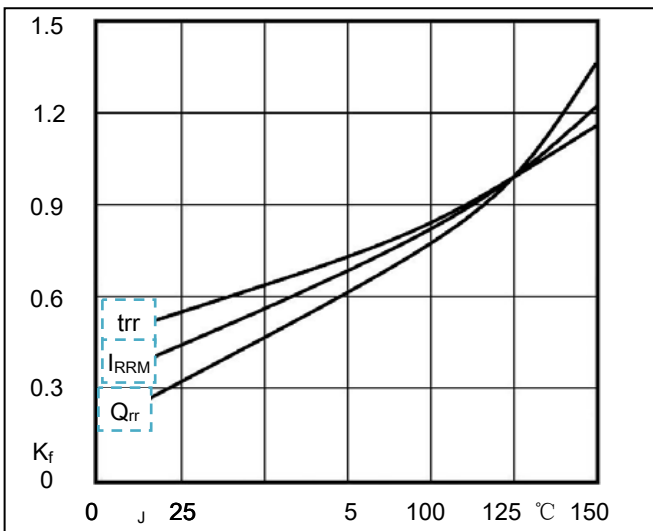

**Fig5. Dynamic Parameters vs Junction Temperature**

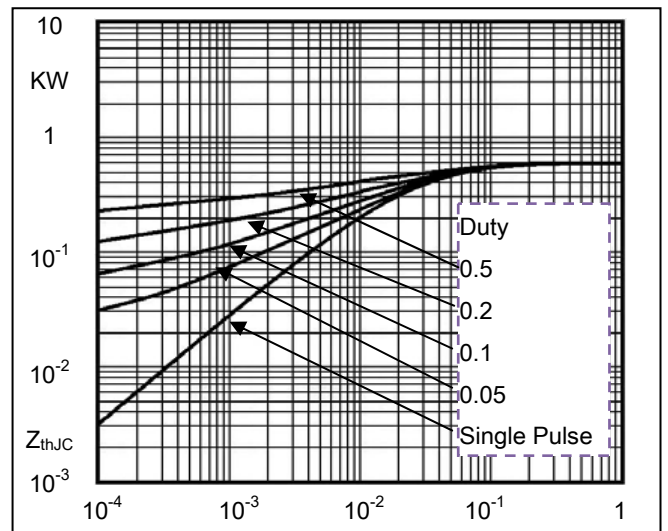

**Fig6. Transient Thermal Impedance**

## Ordering Information

Device	Packing
Part Number-BP	Bulk: 25PCS/BOX ;125PCS/CTN

**\*\*\*IMPORTANT NOTICE\*\*\***

**Micro Commercial Components Corp.** reserves the right to make changes without further notice to any product herein to make corrections, modifications , enhancements , improvements , or other changes . **Micro Commercial Components Corp** . does not assume any liability arising out of the application or use of any product described herein; neither does it convey any license under its patent rights ,nor the rights of others . The user of products in such applications shall assume all risks of such use and will agree to hold **Micro Commercial Components Corp** . and all the companies whose products are represented on our website, harmless against all damages.

**\*\*\*LIFE SUPPORT\*\*\***

MCC's products are not authorized for use as critical components in life support devices or systems without the express written approval of Micro Commercial Components Corporation.

**\*\*\*CUSTOMER AWARENESS\*\*\***

Counterfeiting of semiconductor parts is a growing problem in the industry. Micro Commercial Components (MCC) is taking strong measures to protect ourselves and our customers from the proliferation of counterfeit parts. MCC strongly encourages customers to purchase MCC parts either directly from MCC or from Authorized MCC Distributors who are listed by country on our web page cited below. Products customers buy either from MCC directly or from Authorized MCC Distributors are genuine parts, have full traceability, meet MCC's quality standards for handling and storage. **MCC will not provide any warranty coverage or other assistance for parts bought from Unauthorized Sources.** MCC is committed to combat this global problem and encourage our customers to do their part in stopping this practice by buying direct or from authorized distributors.