

Features

- Ultrafast Reverse Recovery Time
- Low Reverse Recovery Loss
- Low Forward Voltage
- High Surge Current Capability
- Popular SOT-227 Package

Applications

- Inversion Welder
- Uninterruptible Power Supply (UPS)
- Plating Power Supply
- Ultrasonic Cleaner and Welder
- Power Factor Correction (PFC) Circuit
- Converter & Chopper



**200 Amp
FRED Modules
600 Volts**

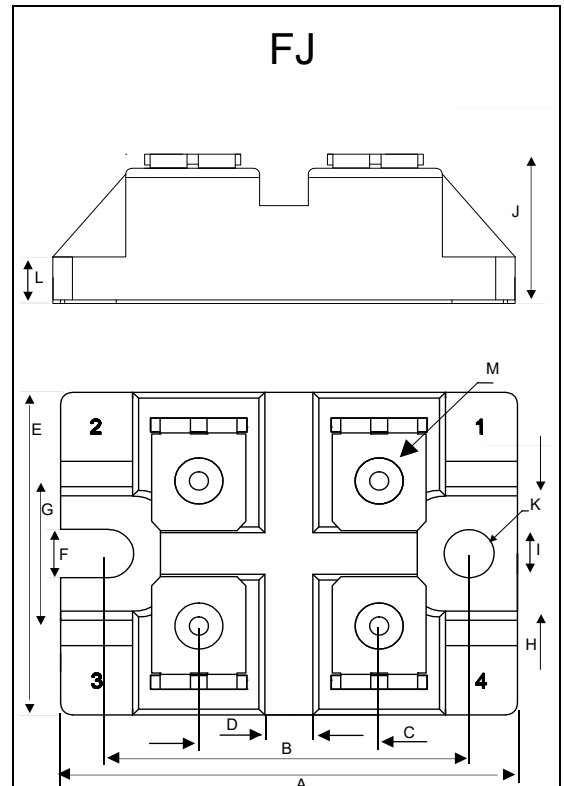

DIM	INCHES		MM		NOTE
	MIN	MAX	MIN	MAX	
A	1.484	1.508	37.50	38.50	
B	1.169	1.193	29.50	30.50	
C	0.579	0.602	14.50	15.50	
D	0.146	0.169	3.50	4.50	
E	1.091	1.114	27.50	28.50	
F	0.154	0.177	3.70	4.70	
G	0.484	0.508	12.10	13.10	
H	0.382	0.406	9.50	10.50	
I	0.130	0.154	3.10	4.10	
J	0.492	0.516	12.30	13.30	
K	0.165		4.20		∅
L	0.146	0.169	3.50	4.50	
M	0.157		4.00		

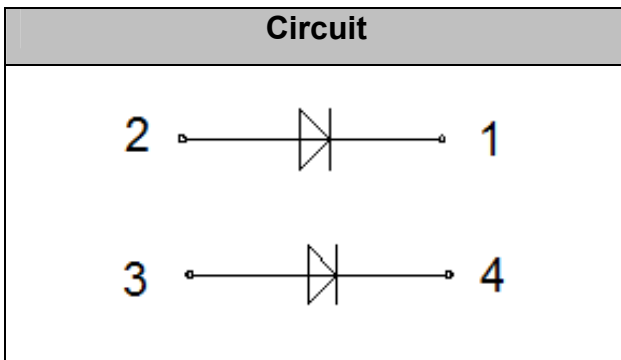

Maximum Ratings

Symbol	Conditions	Values	Units
V_R		600	V
V_{RRM}		600	V
$I_{F(AV)}$	$T_C=90^{\circ}\text{C}$, Per Leg	100	A
	$T_C=90^{\circ}\text{C}$, Per Moudle	200	A
	$T_C=100^{\circ}\text{C}$, 20KHz, Per Moudle	150	A
$I_{F(RMS)}$	$T_C=90^{\circ}\text{C}$, Per Leg	150	A
I_{FSM}	1/2 Cycle , 50Hz, Sine	1300	A
	1/2 Cycle , 60Hz, Sine	1500	A
I^2t	$T_J=45^{\circ}\text{C}$, $t=10\text{ms}$, 50Hz, Sine	8450	A^2s
	$T_J=45^{\circ}\text{C}$, $t=8.3\text{ms}$, 60Hz, Sine	11250	A^2s
P_D	$T_C=25^{\circ}\text{C}$	260	W
T_J		-40 to +150	$^{\circ}\text{C}$
T_{STG}		-40 to +125	$^{\circ}\text{C}$
Visol	3600V AC 1s	1	mA
Torque	To Sink Recommended (M4)	0.6~1.2	N·m
Torque	To Terminal Recommended (M4)	0.6~1	N·m
Weight		27	g

Thermal Characteristics

Symbol	Conditions	Values	Units
$R_{th(j-c)}$	Per diode	0.3	$^{\circ}\text{C}/\text{W}$

Electrical Characteristics

Symbol	Conditions	Values			Units
		Min.	Typ.	Max.	
I_{RM}	$V_R=600\text{V}$	--	--	0.5	mA
	$V_R=600\text{V}$, $T_J=125^{\circ}\text{C}$	--	--	1	mA
V_F	$I_F=100\text{A}$	--	1.2	1.3	V
	$I_F=100\text{A}$, $T_J=125^{\circ}\text{C}$	--	1.1	1.2	V
trr	$I_F=1\text{A}$, $V_R=30\text{V}$, $di_F/dt=-400\text{A}/\mu\text{s}$	--	42	50	ns
trr	$V_R=300\text{V}$, $I_F=100\text{A}$, $di_F/dt=-200\text{A}/\mu\text{s}$, $T_J=25^{\circ}\text{C}$	--	105	--	ns
I_{RRM}		--	10	--	A
trr	$V_R=300\text{V}$, $I_F=100\text{A}$, $di_F/dt=-200\text{A}/\mu\text{s}$, $T_J=125^{\circ}\text{C}$	--	200	--	ns
I_{RRM}		--	18	--	A

Performance Curves

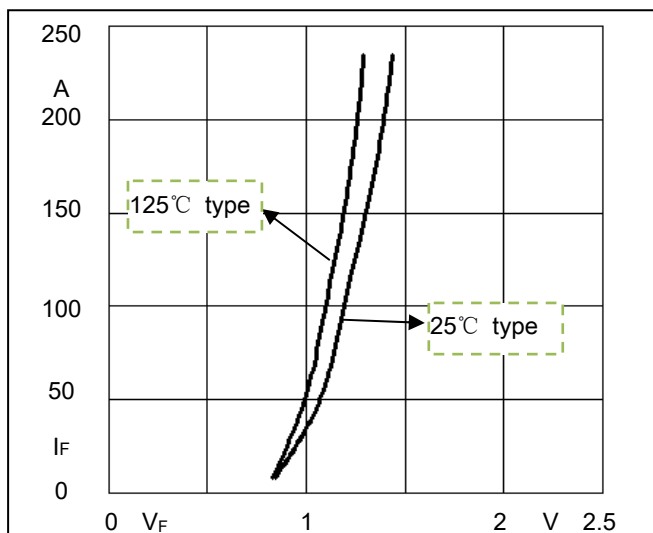

Fig1. Forward Voltage Drop vs Forward Current

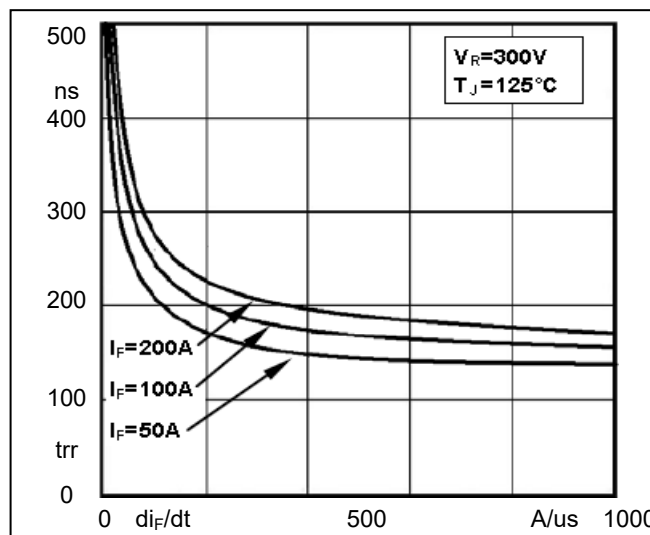

Fig2. Reverse Recovery Time vs di_F/dt

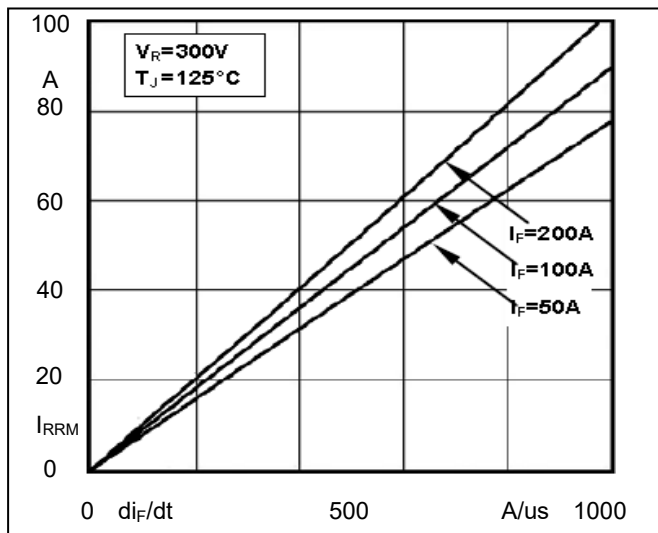

Fig3. Reverse Recovery Current vs di_F/dt

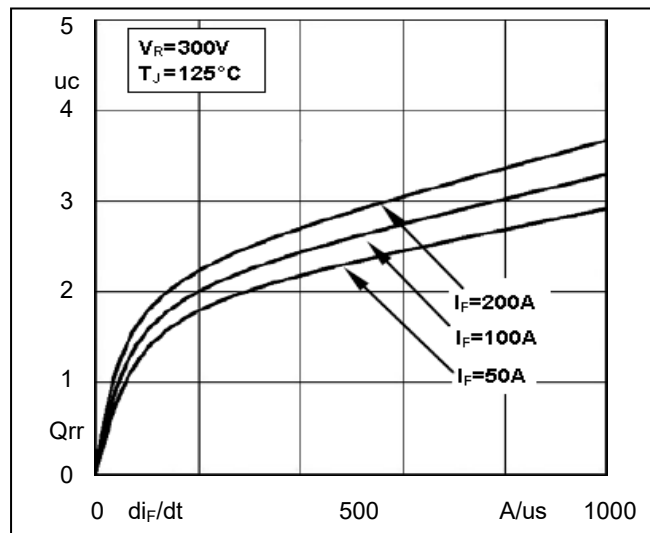

Fig4. Reverse Recovery Charge vs di_F/dt

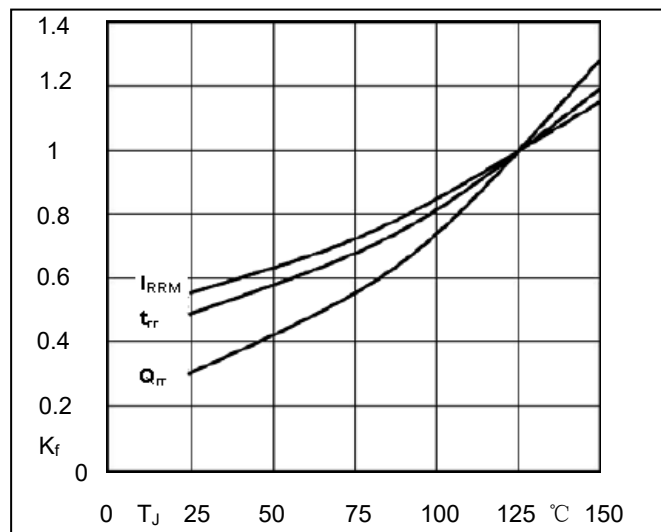

Fig5. Dynamic Parameters vs Junction Temperature

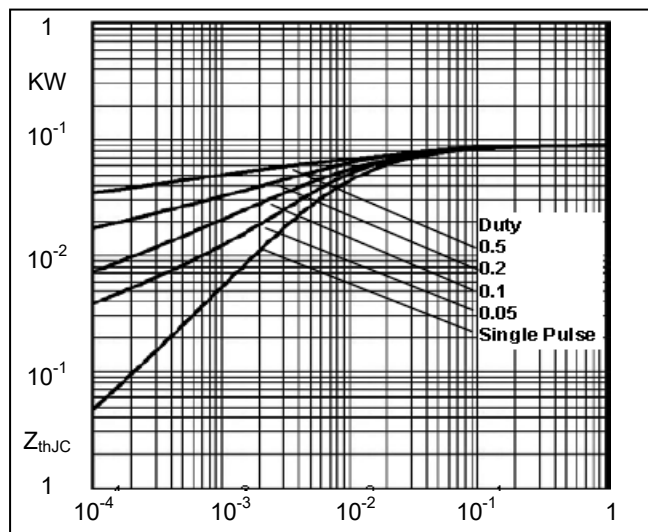

Fig6. Transient Thermal Impedance

Ordering Information

Device	Packing
Part Number-BP	Bulk: 25PCS/BOX ;125PCS/CTN

*****IMPORTANT NOTICE*****

Micro Commercial Components Corp. reserves the right to make changes without further notice to any product herein to make corrections, modifications, enhancements, improvements, or other changes. **Micro Commercial Components Corp.** does not assume any liability arising out of the application or use of any product described herein; neither does it convey any license under its patent rights, nor the rights of others. The user of products in such applications shall assume all risks of such use and will agree to hold **Micro Commercial Components Corp.** and all the companies whose products are represented on our website, harmless against all damages.

*****LIFE SUPPORT*****

MCC's products are not authorized for use as critical components in life support devices or systems without the express written approval of Micro Commercial Components Corporation.

*****CUSTOMER AWARENESS*****

Counterfeiting of semiconductor parts is a growing problem in the industry. Micro Commercial Components (MCC) is taking strong measures to protect ourselves and our customers from the proliferation of counterfeit parts. MCC strongly encourages customers to purchase MCC parts either directly from MCC or from Authorized MCC Distributors who are listed by country on our web page cited below. Products customers buy either from MCC directly or from Authorized MCC Distributors are genuine parts, have full traceability, meet MCC's quality standards for handling and storage. **MCC will not provide any warranty coverage or other assistance for parts bought from Unauthorized Sources.** MCC is committed to combat this global problem and encourage our customers to do their part in stopping this practice by buying direct or from authorized distributors.