

## Features

- Designed for General Purpose Amplifier and Low Speed Switching Applications
- Halogen Free. "Green" Device<sup>(Note 1)</sup>
- Moisture Sensitivity Level 1
- Epoxy Meets UL 94 V-0 Flammability Rating
- Lead Free Finish/RoHS Compliant ("P" Suffix Designates RoHS Compliant. See Ordering Information)

## Maximum Ratings @ 25°C Unless Otherwise Specified

- Operating Junction Temperature Range: -65°C to +150°C
- Storage Temperature Range: -65°C to +150°C
- Thermal Resistance: 9°C/W Junction to Case
- Thermal Resistance: 100°C/W Junction to Ambient<sup>(Note2)</sup>

Parameter	Symbol	Rating	Unit
Collector-Base Voltage	$V_{CBO}$	100	V
Collector-Emitter Voltage	$V_{CEO}$	100	V
Emitter-Base Voltage	$V_{EBO}$	5	V
Continuous Collector Current	$I_C$	3	A
Power Dissipation @ $T_A=25^\circ\text{C}$	$P_D$	1.25	W
Power Dissipation @ $T_C=25^\circ\text{C}$	$P_D$	15	W

Note:

1. Halogen free "Green" products are defined as those which contain <900ppm bromine, <900ppm chlorine (<1500ppm total Br + Cl) and <1000ppm antimony compounds.

2. Device mounted on an FR4 Printed-Circuit Board (PCB), single-sided copper, tin-plated mounting pad for collector 1 cm<sup>2</sup>.

### Internal Structure

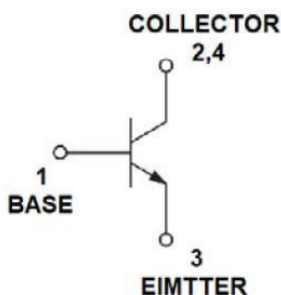

### Device Marking

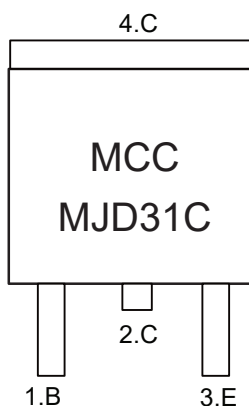

# Silicon NPN epitaxial planer Transistors

## DPAK(TO-252)

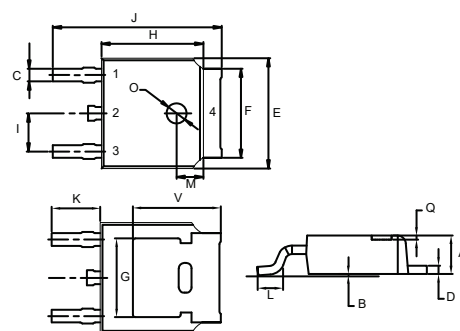

1.BASE  
2,4.COLLECTOR  
3.EMITTER

### DIMENSIONS

DIM	INCHES		MM		NOTE
	MIN	MAX	MIN	MAX	
A	0.087	0.094	2.20	2.40	
B	0.000	0.005	0.00	0.13	
C	0.026	0.034	0.66	0.86	
D	0.018	0.023	0.46	0.58	
E	0.256	0.264	6.50	6.70	
F	0.201	0.215	5.10	5.46	
G	0.190		4.83		TYP.
H	0.236	0.244	6.00	6.20	
I	0.086	0.094	2.18	2.39	
J	0.386	0.409	9.80	10.40	
K	0.114		2.90		TYP.
L	0.055	0.067	1.40	1.70	
M	0.063		1.60		TYP.
O	0.043	0.051	1.10	1.30	
Q	0.000	0.012	0.00	0.30	
V	0.211		5.35		TYP.

**Electrical Characteristics @  $T_A=25^\circ\text{C}$  Unless Otherwise Specified**

Parameter	Symbol	Min	Typ	Max	Units	Conditions
Collector-Base Breakdown Voltage	$V_{(BR)CBO}$	100			V	$I_C=1\text{mA}, I_E=0$
Collector-Emitter Breakdown Voltage	$V_{(BR)CEO}$	100			V	$I_C=30\text{mA}, I_B=0$
Emitter-Base Breakdown Voltage	$V_{(BR)EBO}$	5			V	$I_E=1\text{mA}, I_C=0$
Collector Cutoff Current	$I_{CEO}$			50	$\mu\text{A}$	$V_{CE}=60\text{V}, I_B=0$
Collector Cutoff Current	$I_{CES}$			20	$\mu\text{A}$	$V_{CE}=100\text{V}, V_{EB}=0$
Emitter Cutoff Current	$I_{EBO}$			1	mA	$V_{EB}=5\text{V}, I_C=0$
DC Current Gain	$h_{FE(1)}$	25				$V_{CE}=4\text{V}, I_C=1\text{A}$
	$h_{FE(2)}$	10		75		$V_{CE}=4\text{V}, I_C=3\text{A}$
Collector-Emitter Saturation Voltage	$V_{CE(sat)}$			1.2	V	$I_C=3\text{A}, I_B=0.375\text{A}$
Base-Emitter Voltage	$V_{BE}$			1.8	V	$I_C=3\text{A}, V_{CE}=4\text{V}$
Transition Frequency	$f_T$	3			MHz	$V_{CE}=10\text{V}, I_C=0.5\text{A}, f=1\text{KHz}$

**Curve Characteristics**

Fig. 1 - Static Characteristics

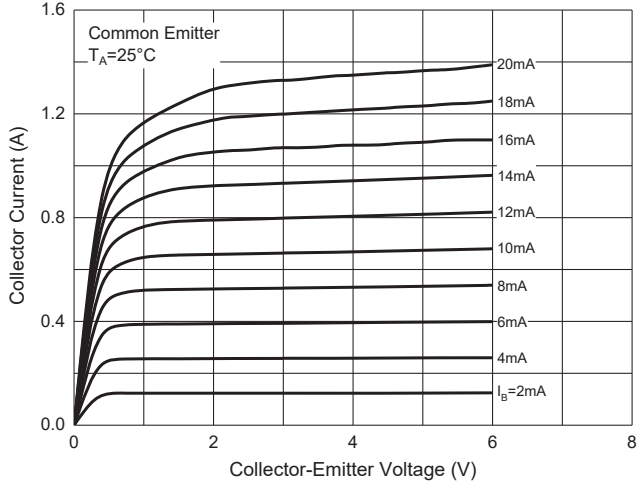

Fig. 2 - DC Current Gain Characteristics

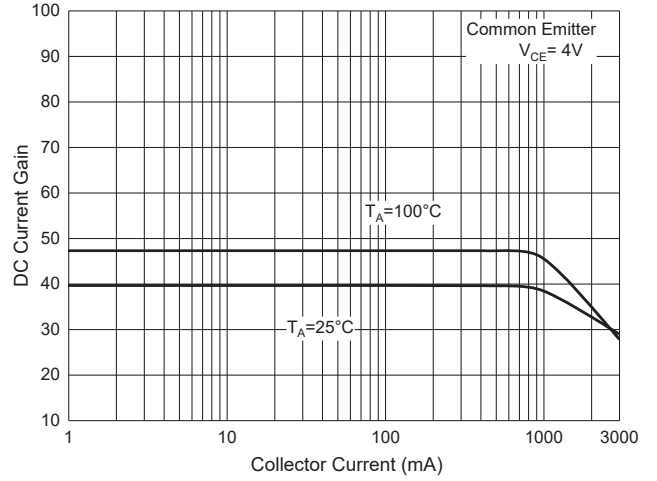

Fig. 3 - Base-Emitter Saturation Voltage Characteristics

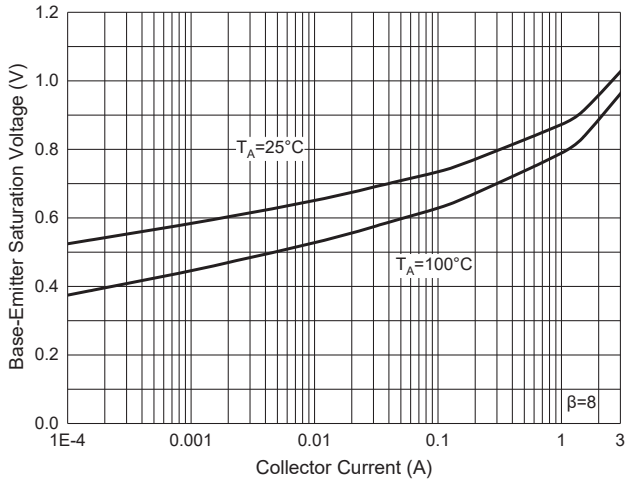

Fig. 4 - Collector-Emitter Saturation Voltage Characteristics

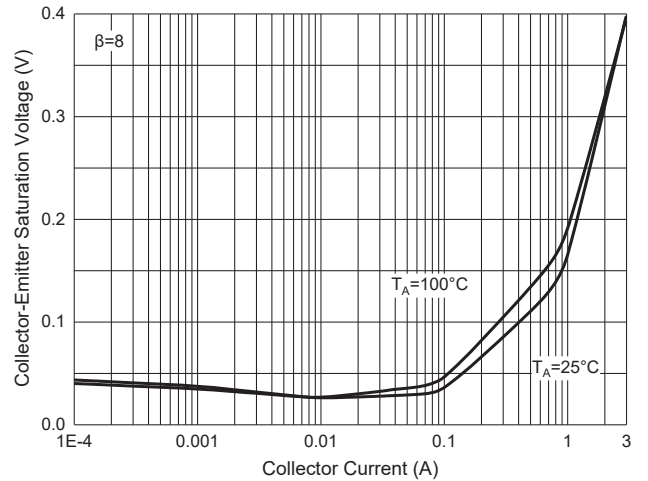

Fig. 5 - Base-Emitter Voltage Characteristics

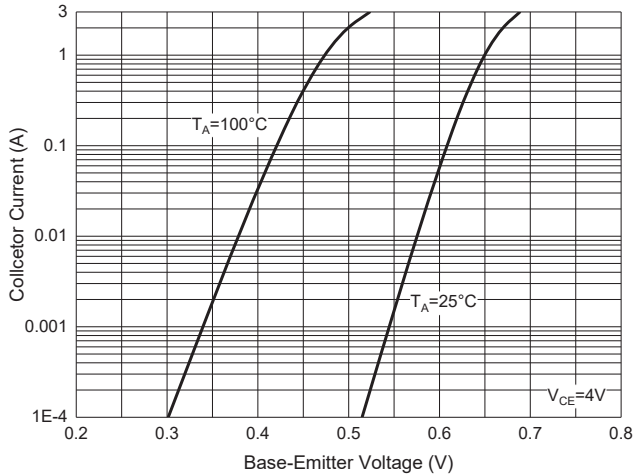
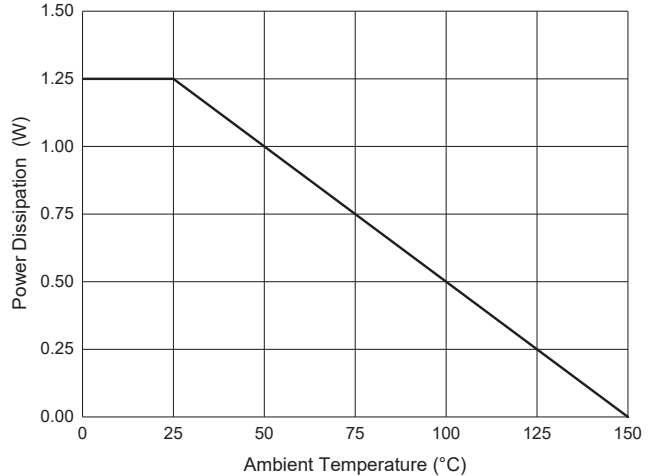

Fig. 6 - Power Derating Curve



Curve Characteristics

Fig. 7 - Power Derating Curve

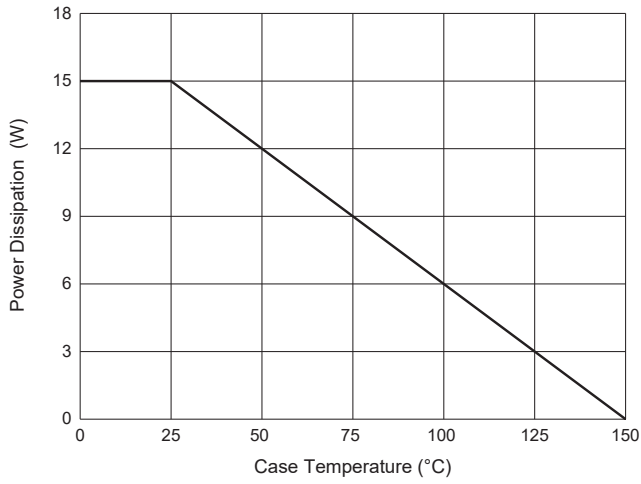
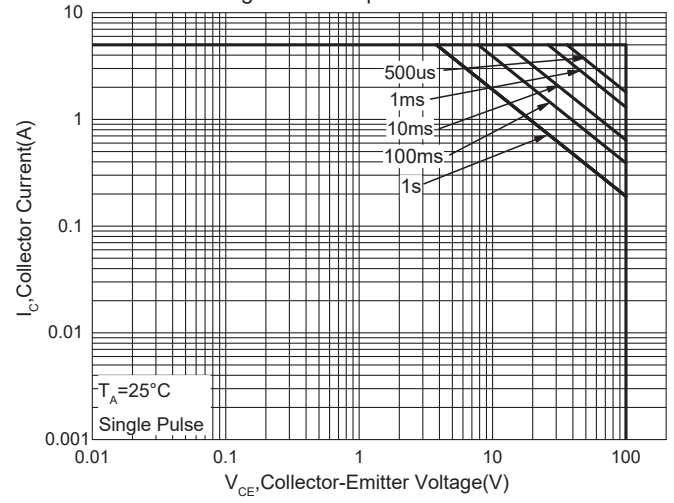

Fig. 8 - Safe Operation Area



## Ordering Information

Device	Packing
Part Number-TP	Tape&Reel: 2.5Kpcs/Reel

### \*\*\*IMPORTANT NOTICE\*\*\*

**Micro Commercial Components Corp.** reserves the right to make changes without further notice to any product herein to make corrections, modifications , enhancements , improvements , or other changes . **Micro Commercial Components Corp.** does not assume any liability arising out of the application or use of any product described herein; neither does it convey any license under its patent rights ,nor the rights of others . The user of products in such applications shall assume all risks of such use and will agree to hold **Micro Commercial Components Corp.** and all the companies whose products are represented on our website, harmless against all damages. **Micro Commercial Components Corp.** products are sold subject to the general terms and conditions of commercial sale, as published at <https://www.mccsemi.com/Home/TermsAndConditions>.

### \*\*\*LIFE SUPPORT\*\*\*

MCC's products are not authorized for use as critical components in life support devices or systems without the express written approval of Micro Commercial Components Corporation.

### \*\*\*CUSTOMER AWARENESS\*\*\*

Counterfeiting of semiconductor parts is a growing problem in the industry. Micro Commercial Components (MCC) is taking strong measures to protect ourselves and our customers from the proliferation of counterfeit parts. MCC strongly encourages customers to purchase MCC parts either directly from MCC or from Authorized MCC Distributors who are listed by country on our web page cited below. Products customers buy either from MCC directly or from Authorized MCC Distributors are genuine parts, have full traceability, meet MCC's quality standards for handling and storage. **MCC will not provide any warranty coverage or other assistance for parts bought from Unauthorized Sources.** MCC is committed to combat this global problem and encourage our customers to do their part in stopping this practice by buying direct or from authorized distributors.