

Features

- Low On-resistance and Low Conduction Loss
- Super Junction technology for High Voltage Application
- Soft Switching with Fast Reverse Recovery Diode
- Ultra Low Gate Charge Cause Lower Driving Requirement
- Epoxy Meets UL 94 V-0 Flammability Rating
- Halogen Free."Green "Device^(Note 1)
- Lead Free Finish/RoHS Compliant. "P" Suffix Designates RoHS Compliant. See Ordering Information

Maximum Ratings

- Operating Junction Temperature Range : -55°C to +150°C
- Storage Temperature Range: -55°C to +150°C
- Thermal Resistance Junction to Ambient,Max^(Note 2): 60°C/W
- Thermal Resistance Junction to Case,Max : 0.9°C/W

Parameter	Symbol	Value	Unit
Drain-Source Voltage	V_{DS}	600	V
Gate-Source Voltage	V_{GS}	±30	V
Continuous Drain Current	I_D	$T_C=25^\circ\text{C}$	17.9
		$T_C=100^\circ\text{C}$	11.3
Pulsed Drain Current ^(Note 3)	I_{DM}	71.6	A
Total Power Dissipation, $T_C=25^\circ\text{C}$	P_D	138	W
Single Avalanche Energy ^(Note 4)	E_{AS}	160	mJ

Note:

1. Halogen free "Green" products are defined as those which contain <900ppm bromine, <900ppm chlorine (<1500ppm total Br + Cl) and <100ppm antimony compounds.
2. Device in a still air environment with $T_A=25^\circ\text{C}$.
3. Repetitive rating; pulse width limited by max. junction temperature.
4. Starting $T_J=25^\circ\text{C}$, $V_{DD}=50\text{V}$, $I_{AS}=4\text{A}$.

Internal Structure and Marking Code

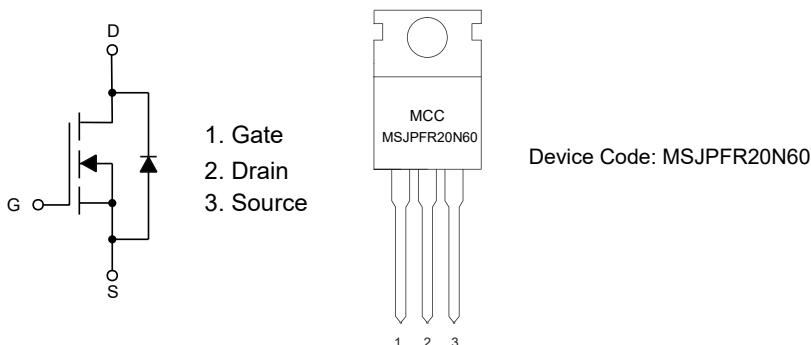

N-CHANNEL Super-Junction Power MOSFET

TO-220AB(H)

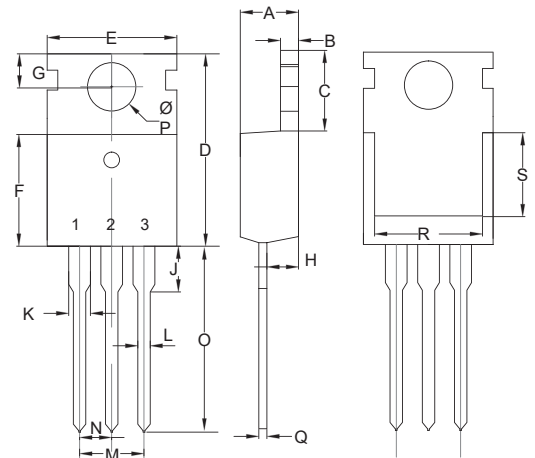

DIM	INCHES		MM		NOTE
	MIN	MAX	MIN	MAX	
A	0.169	0.185	4.30	4.70	
B	0.049	0.055	1.25	1.40	
C	0.244	0.268	6.20	6.80	
D	0.598	0.638	15.20	16.20	
E	0.382	0.398	9.70	10.10	
F	0.354	0.370	9.00	9.40	
G	0.102	0.118	2.60	3.00	
H	0.087	0.102	2.20	2.60	
J	0.110	0.126	2.80	3.20	
K	0.048	0.055	1.22	1.40	
L	0.028	0.037	0.70	0.95	
M	0.188	0.212	4.78	5.38	
N	0.094	0.106	2.39	2.69	
O	0.496	0.535	12.60	13.60	
P	0.138	0.150	3.50	3.80	Φ
Q	0.016	0.024	0.40	0.60	
R	0.276	-----	7.00	-----	
S	0.217	-----	5.50	-----	

Electrical Characteristics ($T_J = 25^\circ\text{C}$ unless otherwise specified)

Parameter	Symbol	Test Conditions	Min	Typ	Max	Unit
Static Characteristics						
Drain-Source Breakdown Voltage	$V_{(BR)DSS}$	$V_{GS}=0V, I_D=1mA$	600			V
Gate-Source Leakage Current	I_{GSS}	$V_{DS}=0V, V_{GS}=\pm 30V$			± 100	nA
Zero Gate Voltage Drain Current	I_{DSS}	$V_{DS}=600V, V_{GS}=0V$			10	μA
Gate-Threshold Voltage	$V_{GS(th)}$	$V_{DS}=V_{GS}, I_D=1.7mA$	3	4.0	5	V
Drain-Source On-Resistance	$R_{DS(on)}$	$V_{GS}=10V, I_D=8.5A$		170	193	m Ω
Gate Resistance	R_g	$f=1MHz, \text{open drain}$		1.3		Ω
Diode Characteristics						
Diode Forward Voltage	V_{SD}	$V_{GS}=0V, I_S=8.5A$			1.2	V
Reverse Recovery Time	t_{rr}	$V_R=300V, I_F=20A$ $di_F/dt=100A/\mu s$		110		ns
Reverse Recovery Charge	Q_{rr}			550		nC
Peak Reverse Recovery Current	I_{rrm}			10		A
Dynamic Characteristics						
Input Capacitance	C_{iss}	$V_{DS}=100V, V_{GS}=0V, f=1MHz$		1240		pF
Output Capacitance	C_{oss}			60		
Output capacitance - energy related	$C_{o(er)}$	$V_{DS}=0 \text{ to } 400V, V_{GS}=0V$		55		
Output capacitance - time related	$C_{o(tr)}$			338		
Total Gate Charge	Q_g	$V_{DS}=300V, V_{GS}=10V, I_D=20A$		30		nC
Gate-Source Charge	Q_{gs}			9		
Gate-Drain Charge	Q_{gd}			15		
Turn-On Delay Time	$t_{d(on)}$	$V_{DD}=300V, V_{GS}=10V$ $R_G=6\Omega, I_D=20A$		16		ns
Turn-On Rise Time	t_r			55		
Turn-Off Delay Time	$t_{d(off)}$			29		
Turn-Off Fall Time	t_f			16		

Typical Characteristics ($T_J=25^\circ\text{C}$ unless otherwise specified)

Fig. 1 - Typical Output Characteristics

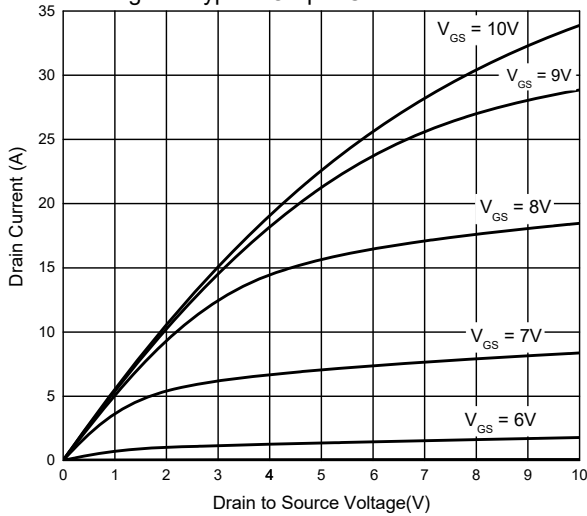

Fig. 2 - Typical Transfer Characteristics

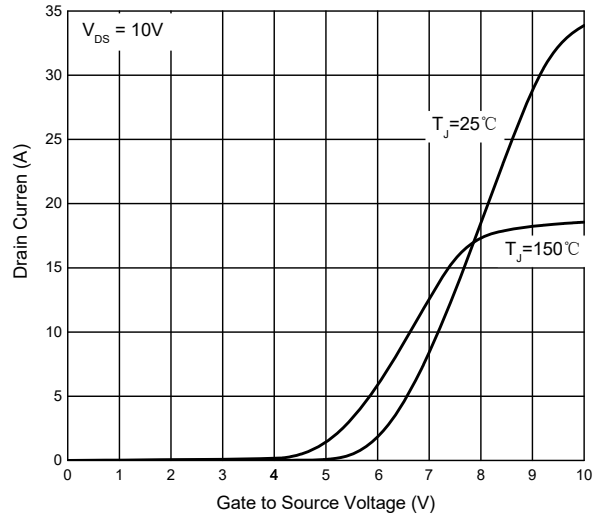

Fig. 3 - On-Resistance vs Gate Bias

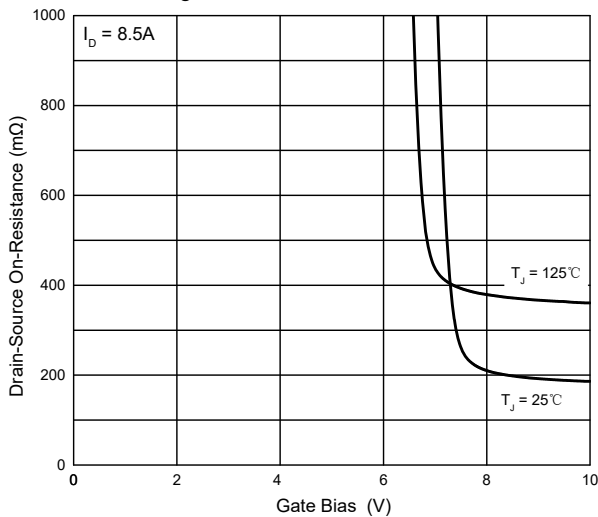

Fig. 4 - On-Resistance vs Drain Current

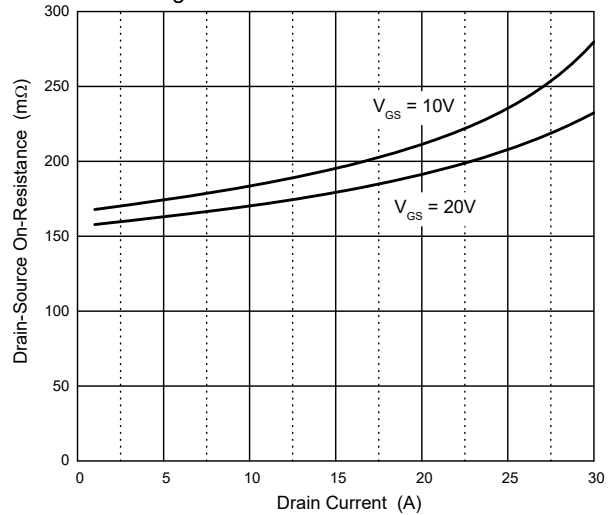

Fig. 5 - Capacitance Characteristic

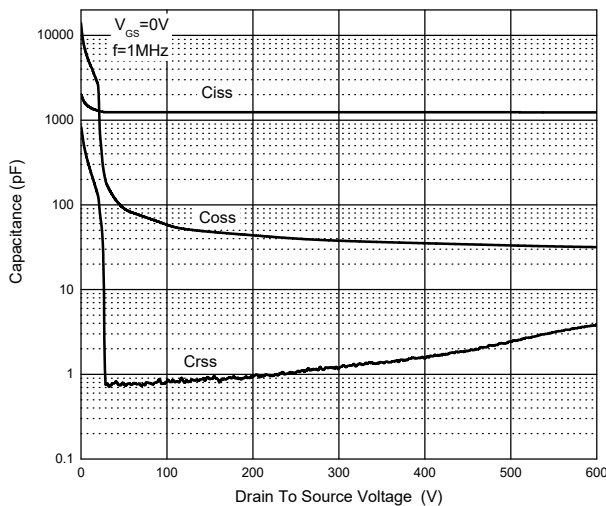
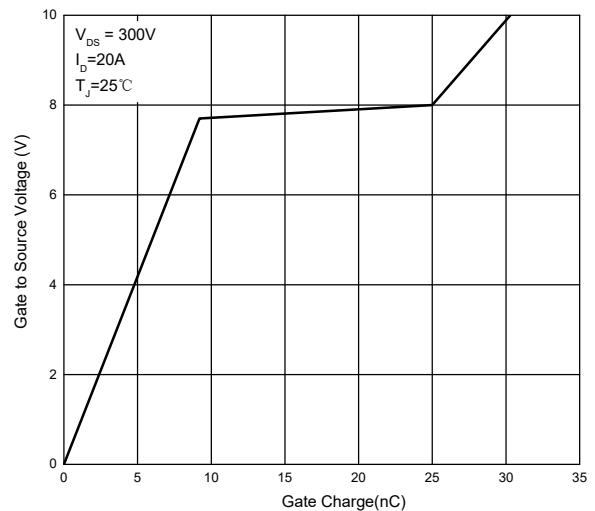

Fig. 6 - Typical Gate Charge



Typical Characteristics ($T_J=25^\circ\text{C}$ unless otherwise specified)

Fig. 7 - Gate-Threshold Voltage vs Junction Temperature

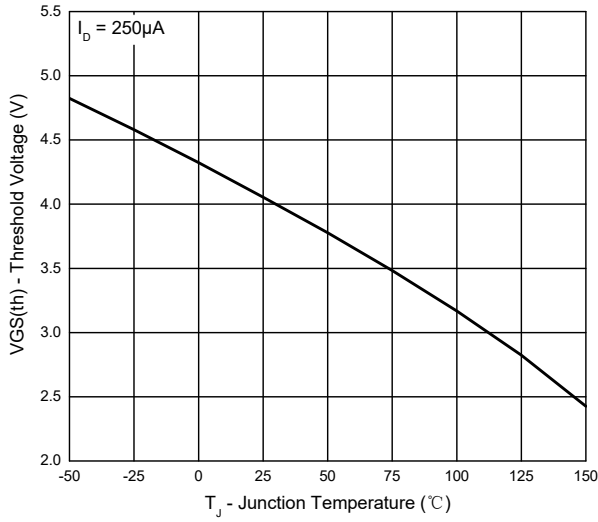

Fig. 8 - Normalized On-Resistance

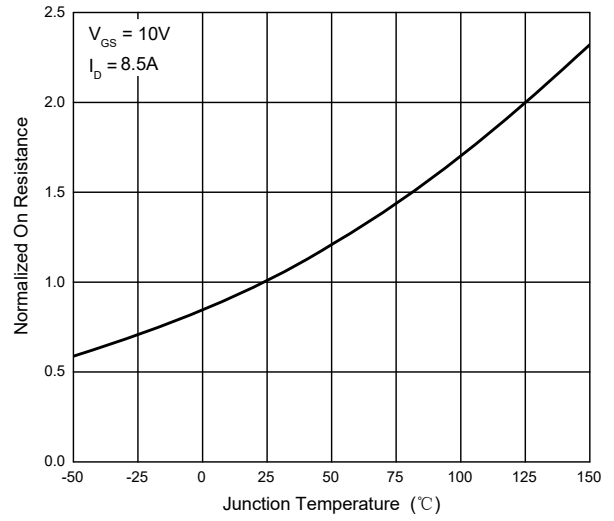

Fig. 9 - Forward Characteristics

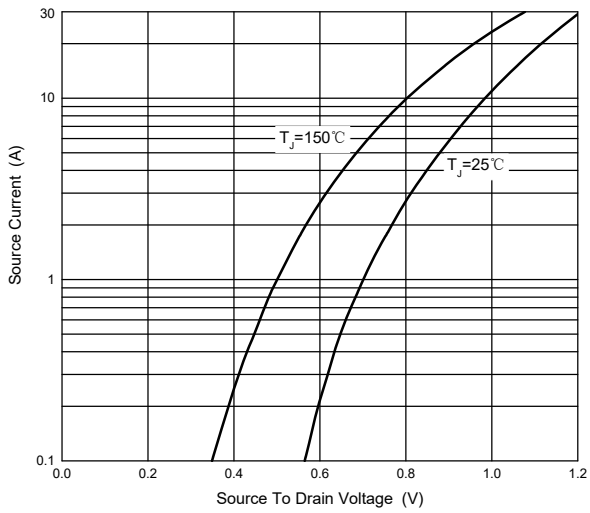

Fig. 10 - Drain Current

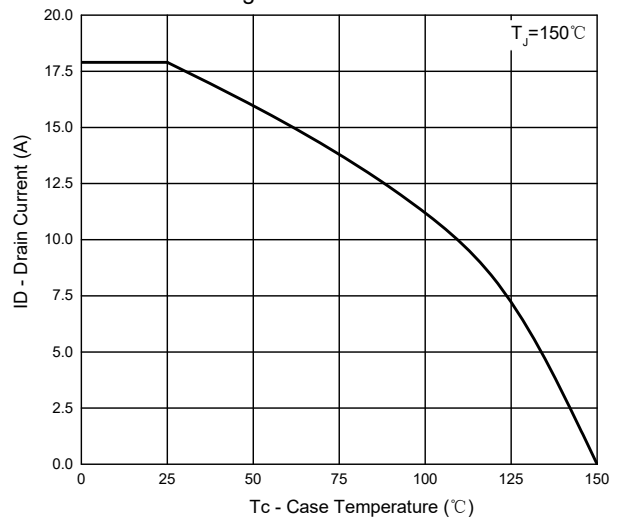

Fig. 11 - Power Dissipation

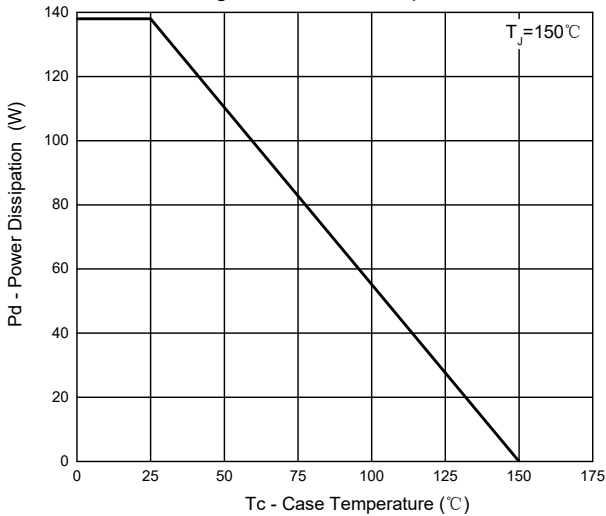
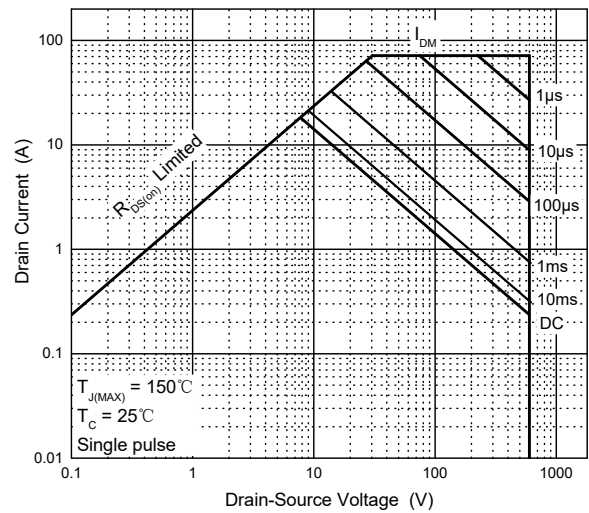
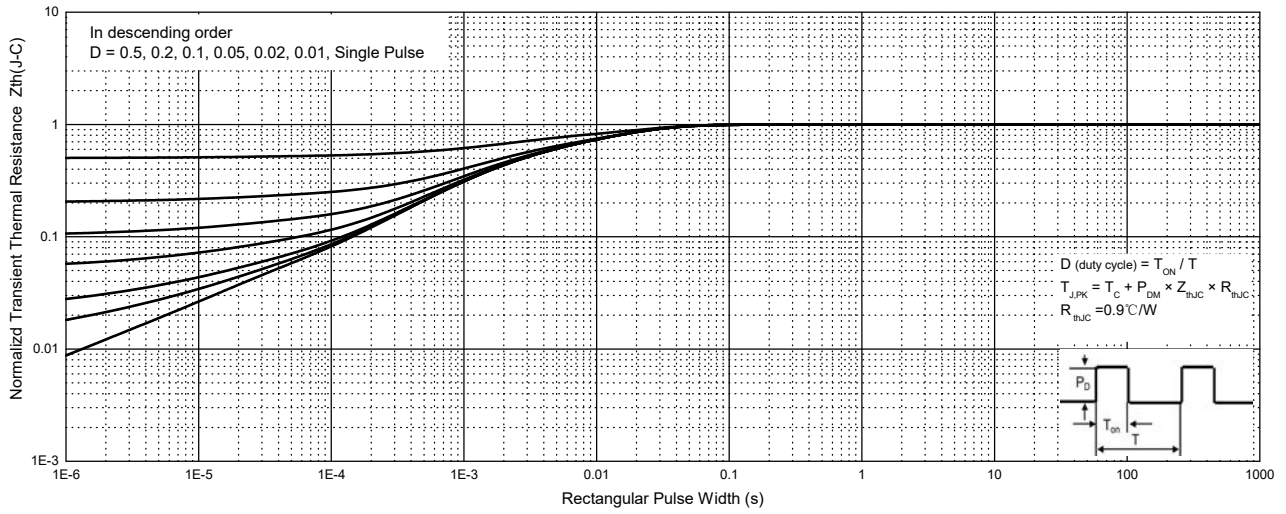

Fig. 12 - Safe Operating Area



Typical Characteristics ($T_J=25^\circ\text{C}$ unless otherwise specified)

Fig.13 - Normalized Transient Thermal Impedance, Junction-Case



Ordering Information

Device	Packing
Part Number-BP	Bulk: 50pcs/Tube; 1Kpcs/Box; 5Kpcs/Ctn

*****IMPORTANT NOTICE*****

Micro Commercial Components Corp. reserves the right to make changes without further notice to any product herein to make corrections, modifications, enhancements, improvements, or other changes. *Micro Commercial Components Corp.* does not assume any liability arising out of the application or use of any product described herein; neither does it convey any license under its patent rights, nor the rights of others. The user of products in such applications shall assume all risks of such use and will agree to hold *Micro Commercial Components Corp.* and all the companies whose products are represented on our website, harmless against all damages. *Micro Commercial Components Corp.* products are sold subject to the general terms and conditions of commercial sale, as published at <https://www.mccsemi.com/Home/TermsAndConditions>

*****LIFE SUPPORT*****

MCC's products are not authorized for use as critical components in life support devices or systems without the express written approval of Micro Commercial Components Corporation.

*****CUSTOMER AWARENESS*****

Counterfeiting of semiconductor parts is a growing problem in the industry. Micro Commercial Components (MCC) is taking strong measures to protect ourselves and our customers from the proliferation of counterfeit parts. MCC strongly encourages customers to purchase MCC parts either directly from MCC or from Authorized MCC Distributors who are listed by country on our web page cited below. Products customers bought either from MCC directly or from Authorized MCC Distributors are genuine parts, have full traceability, meet MCC's quality standards for handling and storage. **MCC will not provide any warranty coverage or other assistance for parts bought from Unauthorized Sources.** MCC is committed to combat this global problem and encourages our customers to do their parts in stopping this practice by buying directly or from authorized distributors.