

Features

- SiC MOSFET Technology
- High Speed Switching
- Reduction Of Heat Sink Requirements
- Essentially No Switching Losses
- Halogen Free. "Green" Device (Note 1)
- Lead Free Finish/RoHS Compliant("P" Suffix Designates RoHS Compliant. See Ordering Information) (Note2)

Maximum Ratings

- Operating Junction Temperature Range : -55°C to +175°C
- Storage Temperature Range: -55°C to +175°C
- Thermal Resistance Junction to Ambient,Max(Note 3): 62°C/W
- Thermal Resistance Junction to Case,Typ : 0.67°C/W

Applications

- Solar Inverters
- Uninterruptible Power Supply
- Photovoltaic Inverter
- Battery Chargers
- Motor Drives

Parameter	Symbol	Rating	Unit	
Drain-Source Voltage	V_{DS}	1200	V	
Gate-Source Voltage ^(Note 4)	V_{GSmax}	-10/+25	V	
Gate-Source Voltage	V_{GSop}	-5/+20	V	
Continuous Drain Current $V_{GS}=20V$	I_D	$T_C=25^\circ C$	33	A
		$T_C=110^\circ C$	24	
Pulsed Drain Current ^(Note 5)	I_{DM}	81	A	
Total Power Dissipation	P_D	$T_C=25^\circ C$	224	W
		$T_C=110^\circ C$	97	

Note1:Halogen free "Green" products are defined as those which contain <900ppm bromine, <900ppm chlorine (<1500ppm total Br + Cl) and <1000ppm antimony compounds.

Note2:High Temperature Solder Exemptions Applied, see EU Directive Annex 7a.

Note3:Device in a still air environment with $T_A=25^\circ C$.

Note4:AC $f > 1Hz$, duty cycle < 1%

Note5:Pulse Test: Pulse Width Limited by T_{jmax} .

Internal Structure and Marking Code

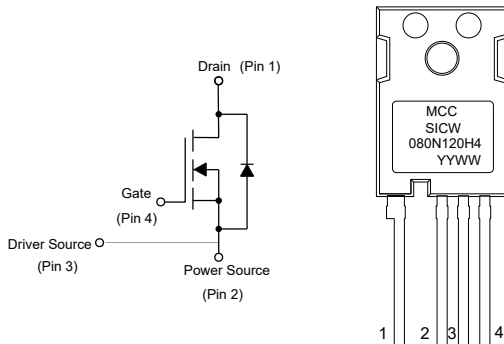

Device Code: SICW080N120H4
Date Code: YYWW (Year & Week)

SiC N-CHANNEL MOSFET

TO-247-4

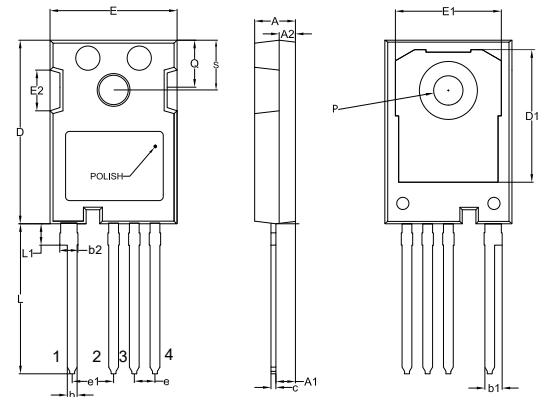

DIM	INCHES		MM		NOTE
	MIN	MAX	MIN	MAX	
A	0.189	0.205	4.80	5.20	
A1	0.090	0.098	2.29	2.50	
A2	0.074	0.082	1.88	2.08	
b	0.043	0.054	1.10	1.36	
b1	0.093	0.108	2.35	2.75	
b2	0.094	0.112	2.39	2.84	
c	0.022	0.028	0.55	0.70	
D	0.917	0.929	23.30	23.60	
D1	0.640	0.663	16.25	16.85	
E	0.620	0.632	15.75	16.05	
E1	0.543	0.559	13.80	14.20	
E2	0.173	0.201	4.4	5.10	
e	0.100		2.54		
e1	0.199		5.06		
L	0.683	0.694	17.34	17.64	
L1	0.157	0.169	4.00	4.30	
P	0.138	0.148	3.51	3.75	Φ
Q	0.220	0.236	5.60	6.00	
S	0.220	0.248	5.60	6.30	

Electrical Characteristics @ T_j=25°C (Unless Otherwise Specified)

Parameter	Symbol	Test Conditions	Min	Typ	Max	Unit	
Static Characteristics							
Drain-Source Breakdown Voltage	V _{(BR)DSS}	V _{GS} =0V, I _D =100μA	1200			V	
Gate-Source Leakage Current	I _{GSS}	V _{DS} =0V, V _{GS} =20V			250	nA	
Zero Gate Voltage Drain Current	I _{DSS}	V _{DS} =1200V, V _{GS} =0V			50	μA	
Gate-Threshold Voltage	V _{GS(th)}	V _{DS} =V _{GS} , I _D =20mA	2	3.0	4.5	V	
Drain-Source On-Resistance	R _{DS(on)}	V _{GS} =20V, I _D =15A		80	110	mΩ	
		V _{GS} =20V, I _D =15A, T _j =175°C		134		mΩ	
Internal Gate Resistance	R _g	f=1MHz, V _{AC} =25mV		0.75		Ω	
Transconductance	g _{FS}	V _{DS} =9.8V, I _D =15A		6.5		S	
Dynamic Characteristics							
Input Capacitance	C _{iss}	V _{DS} =800V, V _{GS} =0V, f=1MHz, V _{AC} =25mV		2644		pF	
Output Capacitance	C _{oss}			85			
Reverse Transfer Capacitance	C _{rss}			8			
Coss Stored Energy	E _{oss}			33		μJ	
Total Gate Charge	Q _g	V _{DS} =800V, V _{GS} =-5/+20V, I _D =20A		131		nC	
Gate-Source Charge	Q _{gs}			53			
Gate-Drain Charge	Q _{gd}			23			
Turn-On Delay Time	t _{d(on)}	V _{DD} =800V, V _{GS} =-5/+20V, R _G =2.7Ω, I _D =20A, R _L =40Ω		28		ns	
Rise Time	t _r			64			
Turn-Off Delay Time	t _{d(off)}			60			
Fall Time	t _f			26.4			
Turn-On switching energy	E _{on}	V _{DD} =800V, V _{GS} =-5/+20V, R _G =2.7Ω, I _D =20A		22		μJ	
Turn-Off switching energy	E _{off}			22			
Diode Characteristics							
Continuous Body Diode Current	I _S	V _{GS} =0V, T _C =25°C		36		A	
Diode Forward Voltage	V _{SD}	V _{GS} =0V, I _{SD} =5A		3		V	
Reverse Recovery Time	t _{rr}	V _{GS} =0V, I _{SD} =20A, V _{DS} =400V, dI _F /dt=300A/μs		50		ns	
Reverse Recovery Charge	Q _{rr}				81		nC
Peak Reverse Recovery Current	I _{rrm}				3.2		A

Curve Characteristics ($T_J=25^\circ\text{C}$ unless otherwise specified)

Fig. 1 - Typical Output Characteristic ($T_J=25^\circ\text{C}$)

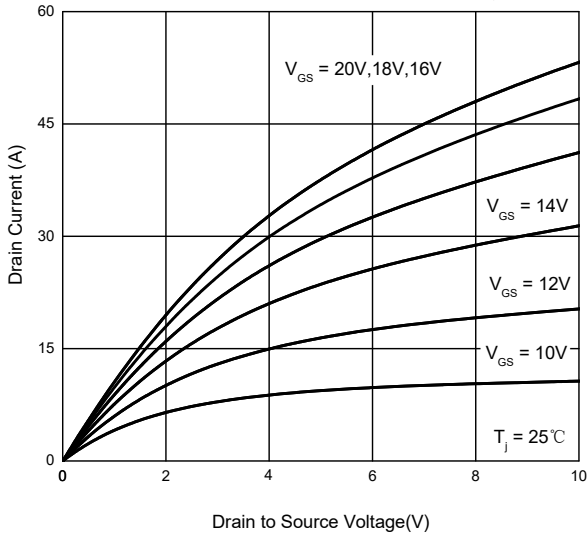

Fig. 2 - Typical Output Characteristic ($T_J=175^\circ\text{C}$)

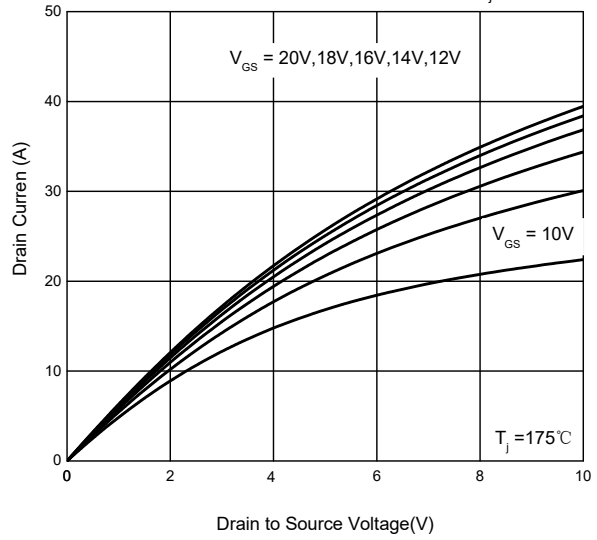

Fig. 3 - On-Resistance vs. Drain Current

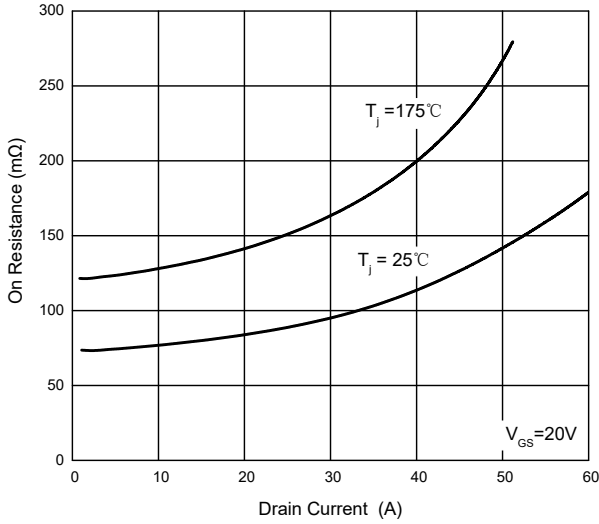

Fig. 4 - Typical Transfer Characteristic

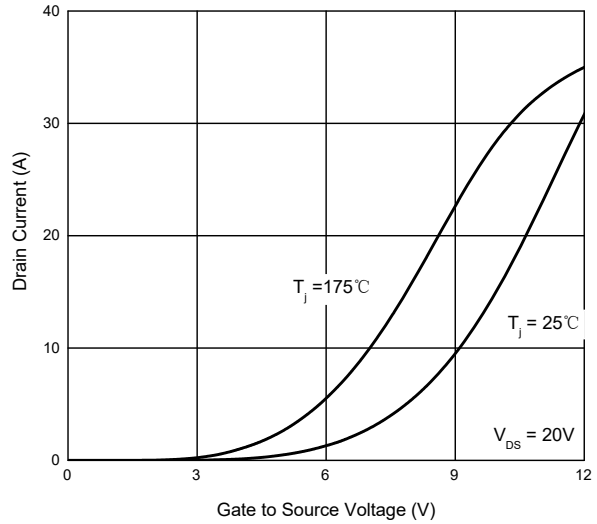

Fig. 5 - On-Resistance vs. Gate Voltage

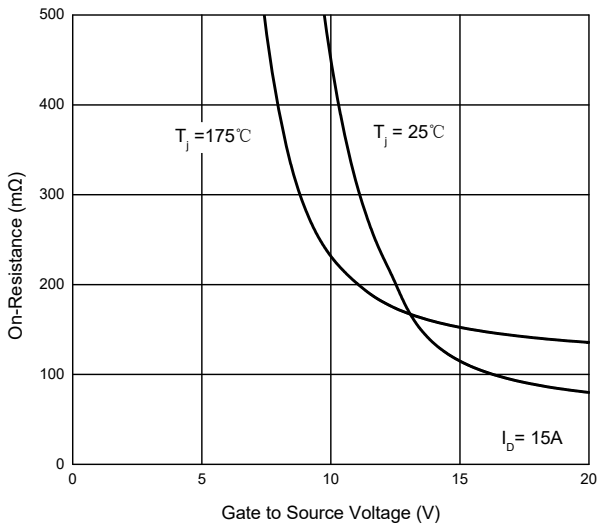
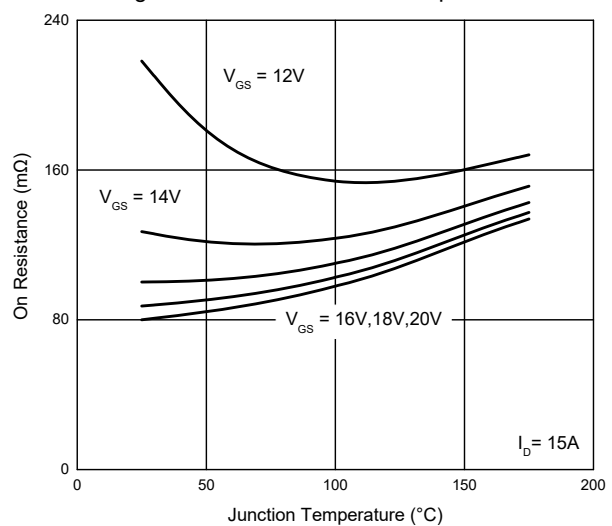

Fig. 6 - On-Resistance vs. Temperature



Curve Characteristics ($T_J=25^\circ\text{C}$ unless otherwise specified)

Fig. 7 - Normalized On-Resistance vs. Temperature

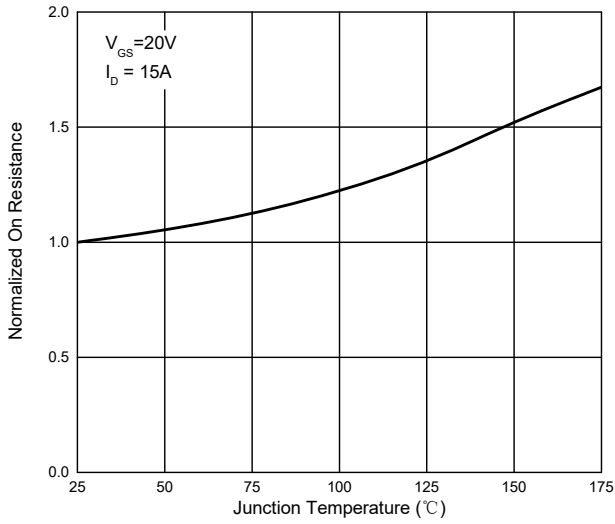

Fig. 8 - Reverse Output Voltage

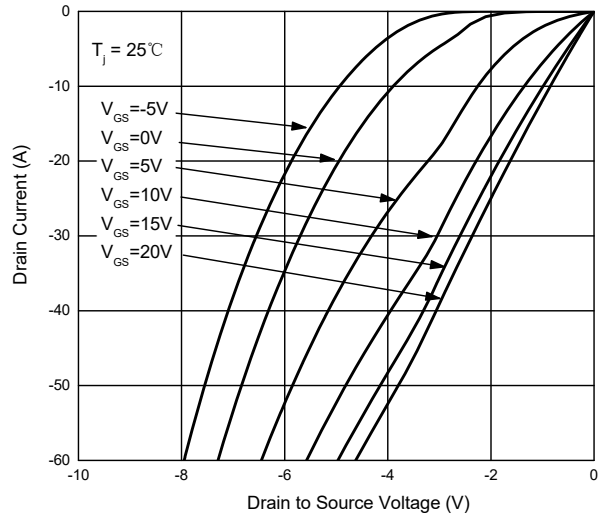

Fig. 9 - Reverse Output Voltage

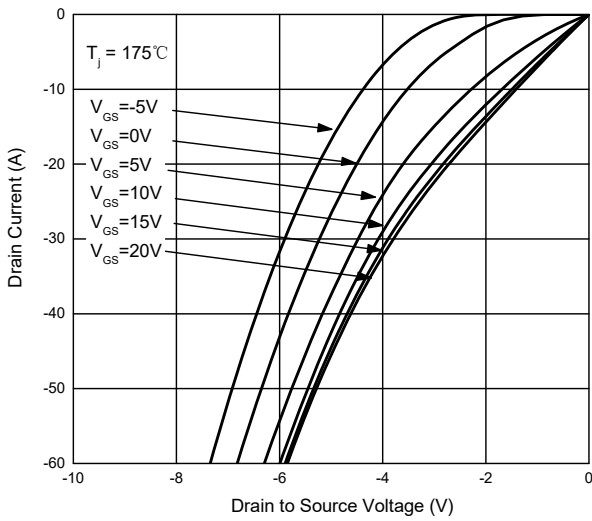

Fig. 10 - Capacitances vs. V_{DS}

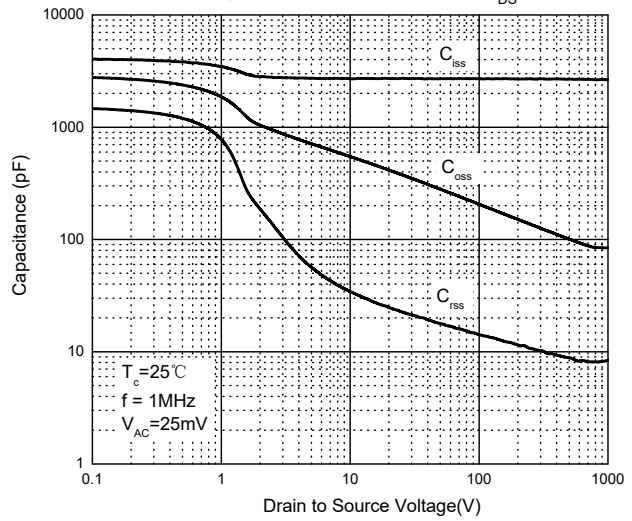

Fig. 11 - Threshold Voltage vs. Temperature

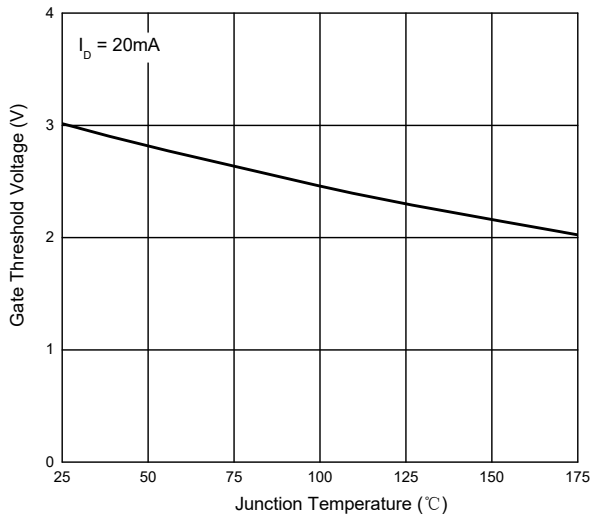
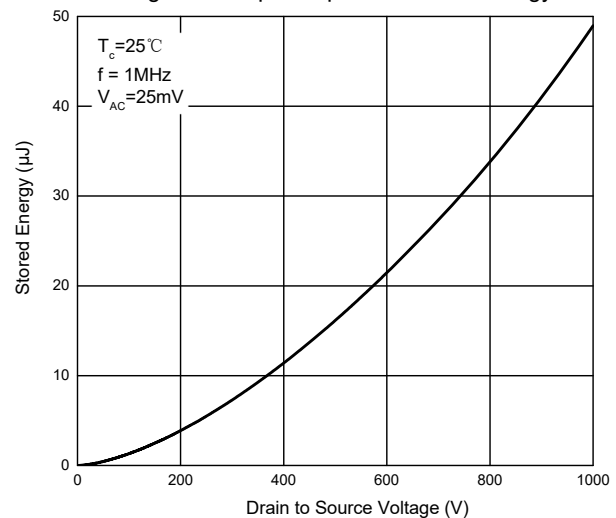

Fig. 12 - Output Capacitor Stored Energy



Curve Characteristics ($T_J=25^\circ\text{C}$ unless otherwise specified)

Fig. 13 - Power Derating

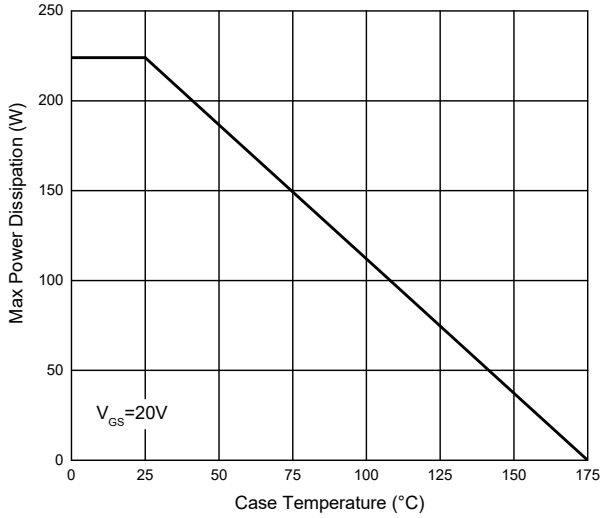

Fig. 14 - Drain Current Derating

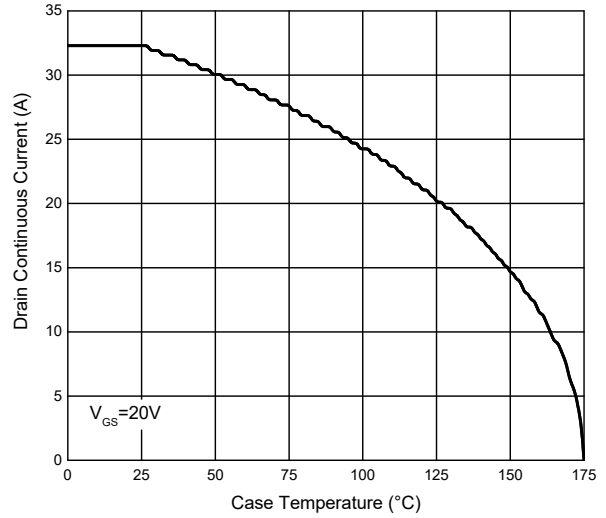

Fig. 15 - Safe Operation Area

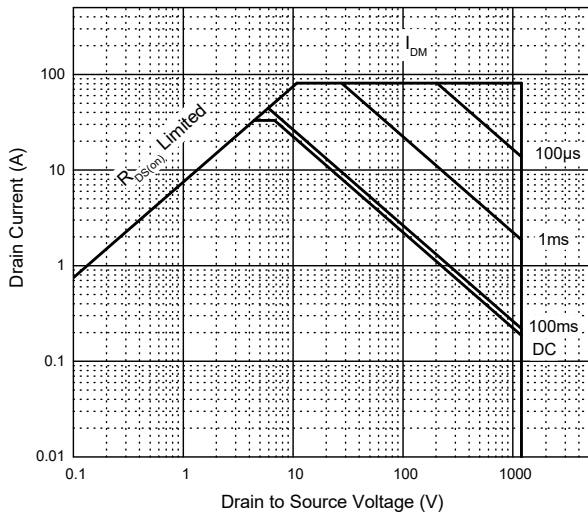

Fig. 16 - Typical Gate Charge

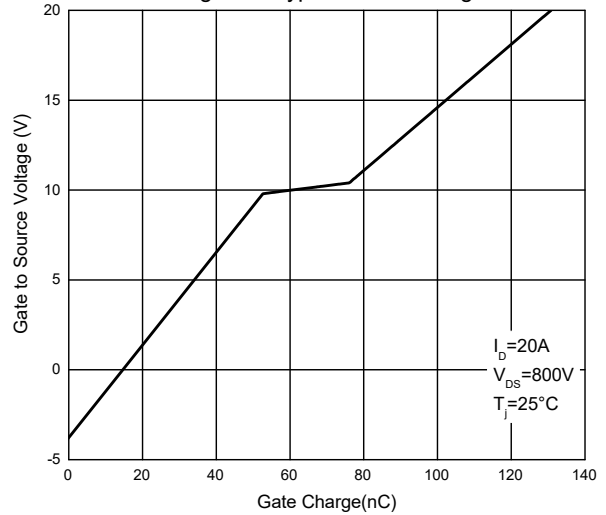

Fig. 17 - Clamped Inductive Switching Energy vs. Drain Current

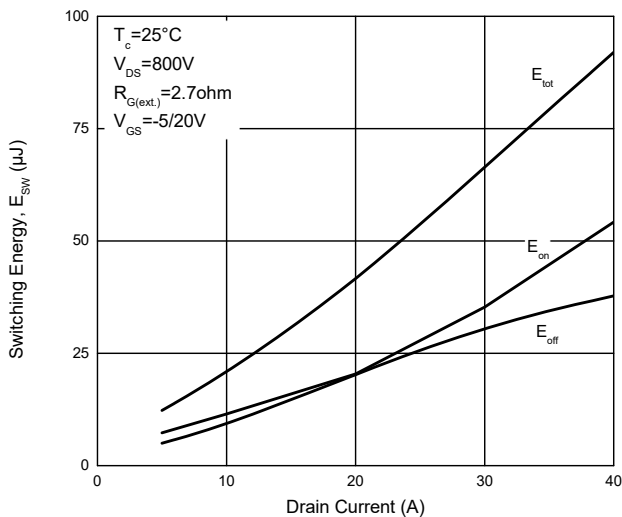
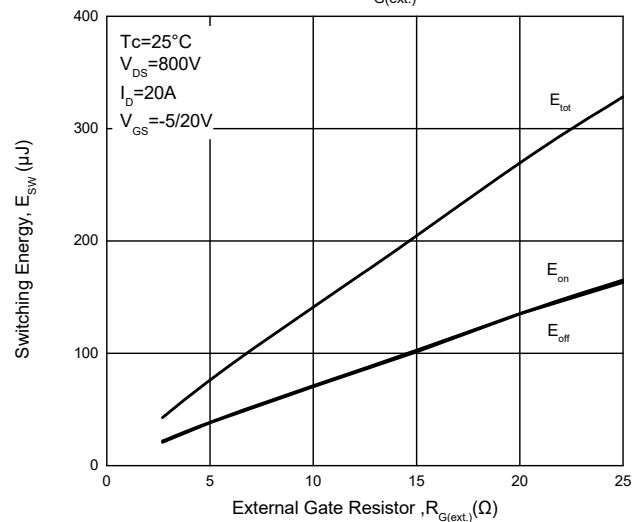
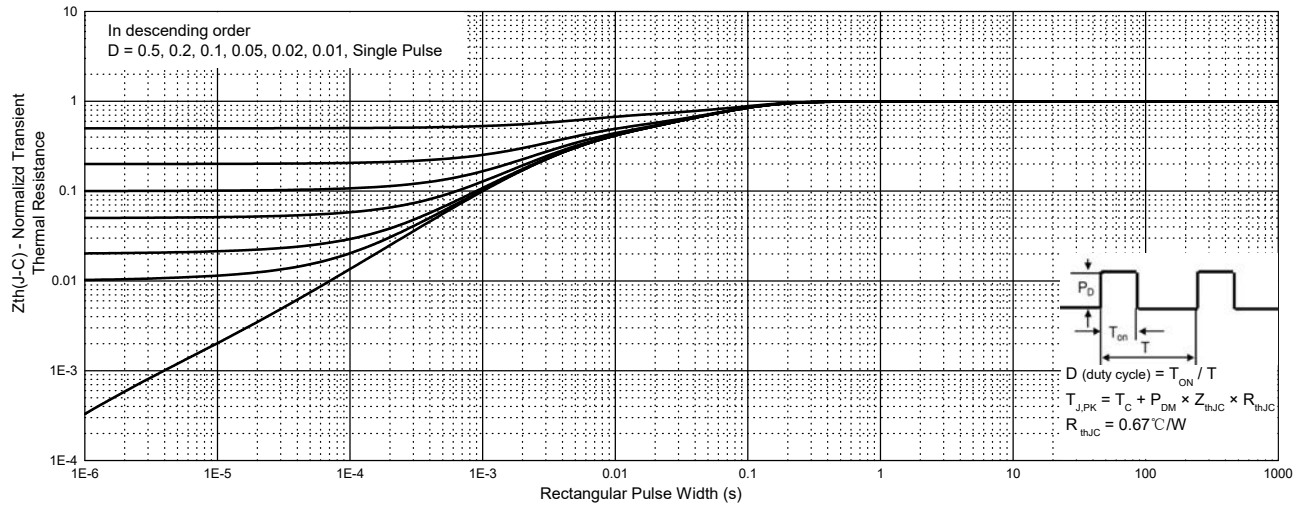

Fig. 18 - Clamped Inductive Switching Energy vs. External Gate Resistor ($R_{G(ext.)}$)



Curve Characteristics ($T_J=25\text{ C}$ unless otherwise specified)

Fig.19 - Normalized Transient Thermal Impedance



Ordering Information

Device	Packing
SICW080N120H4-BP	Tube:30pcs/Tube, 1.8K/Ctn;

*****IMPORTANT NOTICE*****

Micro Commercial Components Corp. reserves the right to make changes without further notice to any product herein to make corrections, modifications, enhancements, improvements, or other changes. **Micro Commercial Components Corp.** does not assume any liability arising out of the application or use of any product described herein; neither does it convey any license under its patent rights, nor the rights of others. The user of products in such applications shall assume all risks of such use and will agree to hold **Micro Commercial Components Corp.** and all the companies whose products are represented on our website, harmless against all damages. **Micro Commercial Components Corp.** products are sold subject to the general terms and conditions of commercial sale, as published at <https://www.mccsemi.com/Home/TermsAndConditions>.

*****LIFE SUPPORT*****

MCC's products are not authorized for use as critical components in life support devices or systems without the express written approval of Micro Commercial Components Corporation.

*****CUSTOMER AWARENESS*****

Counterfeiting of semiconductor parts is a growing problem in the industry. Micro Commercial Components (MCC) is taking strong measures to protect ourselves and our customers from the proliferation of counterfeit parts. MCC strongly encourages customers to purchase MCC parts either directly from MCC or from Authorized MCC Distributors who are listed by country on our web page cited below. Products customers buy either from MCC directly or from Authorized MCC Distributors are genuine parts, have full traceability, meet MCC's quality standards for handling and storage. **MCC will not provide any warranty coverage or other assistance for parts bought from Unauthorized Sources.** MCC is committed to combat this global problem and encourage our customers to do their part in stopping this practice by buying direct or from authorized distributors.