

Features

- Lead Free Finish/RoHS Compliant(Note 1) ("P" Suffix Designates Compliant. See Ordering Information)
- For Surface Mount Applications
- High Current Capability With Low Forward Voltage
- Easy Pick And Place
- Halogen Free. "Green" Device (Note 2)

Maximum Ratings

- Operating Junction Temperature Range: -55°C to +125°C
- Storage Temperature Range: -55°C to +150°C
- Typical Thermal Resistance: 50°C/W Junction to Ambient(Note 3)
- Typical Thermal Resistance: 12°C/W Junction to Lead(Note 3)
- Typical Thermal Resistance: 7°C/W Junction to Case(Note 3)

MCC Part Number	Device Marking	Maximum Recurrent Peak Reverse Voltage	Maximum RMS Voltage	Maximum DC Blocking Voltage
SK1545-L	SK1545	45V	31.5V	45V

Electrical Characteristics @ 25°C Unless Otherwise Specified

Average Forward Current	$I_{F(AV)}$	15A	$T_C=65^\circ\text{C}$
Peak Forward Surge Current	I_{FSM}	300A	8.3ms, Half Sine
Instantaneous Forward Voltage	V_F	0.52V(Typ.) 0.55V(Max.)	$I_{FM}=15A; T_J=25^\circ\text{C}$ $I_{FM}=15A; T_J=25^\circ\text{C}$
Maximum DC Reverse Current at Rated DC Blocking Voltage	I_R	0.2mA 20mA	$T_J=25^\circ\text{C}$ $T_J=100^\circ\text{C}$
Typical Junction Capacitance	C_J	680pF	$V_R=4V; f=1\text{MHz}; T_J=25^\circ\text{C}$

Note:

1. High Temperature Solder Exemptions Applied, See EU Directive Annex 7a.
2. Halogen free "Green" products are defined as those which contain <900ppm bromine, <900ppm chlorine (<1500ppm total Br + Cl) and <1000ppm antimony compounds.
3. Mounted on P.C.B. with 0.6" x 0.6" (16 mm x 16 mm) copper pad areas.

15 Amp Schottky Rectifier 45 Volts

SMC (DO-214AB)

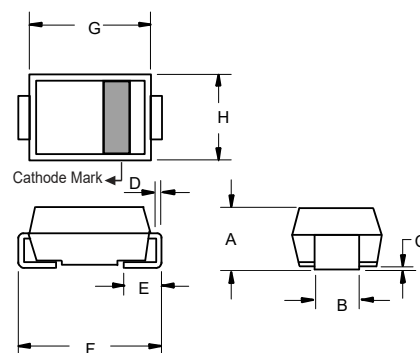

DIM	DIMENSIONS				NOTE
	INCHES		MM		
	MIN	MAX	MIN	MAX	
A	0.079	0.103	2.00	2.62	
B	0.108	0.128	2.75	3.25	
C	0.002	0.008	0.051	0.203	
D	0.006	0.012	0.152	0.305	
E	0.030	0.060	0.76	1.52	
F	0.305	0.320	7.75	8.13	
G	0.260	0.280	6.60	7.11	
H	0.220	0.245	5.59	6.22	

Suggested Solder Pad Layout

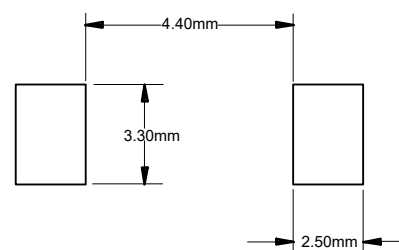

Curve Characteristics

Fig. 1 - Forward Current Derating Curve

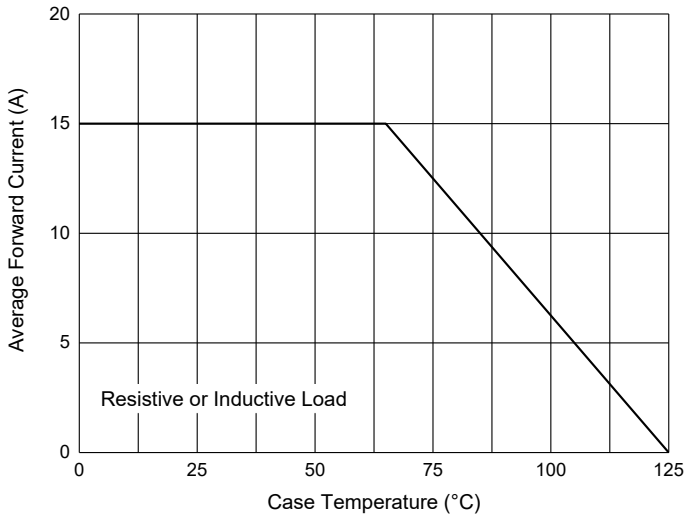

Fig. 2 - Maximum Non-Repetitive Peak Forward Surge Current

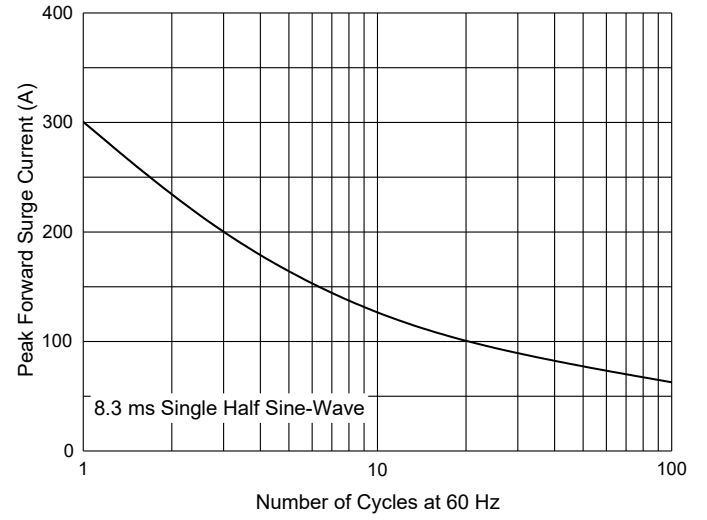

Fig. 3 - Typical Instantaneous Forward Characteristics

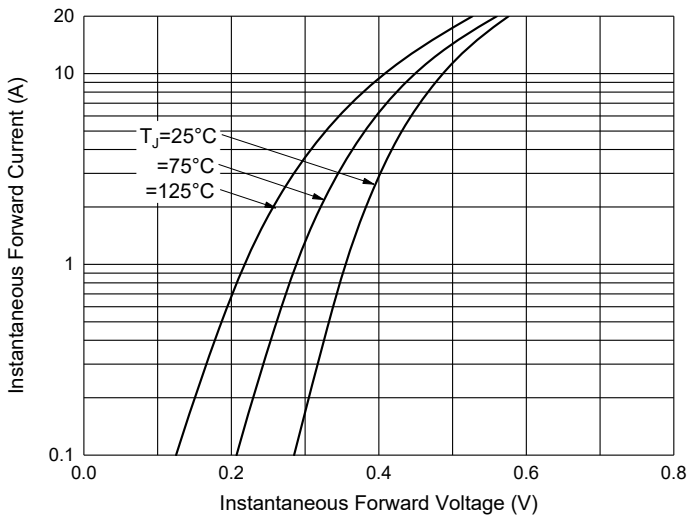

Fig. 4 - Typical Reverse Leakage Characteristics

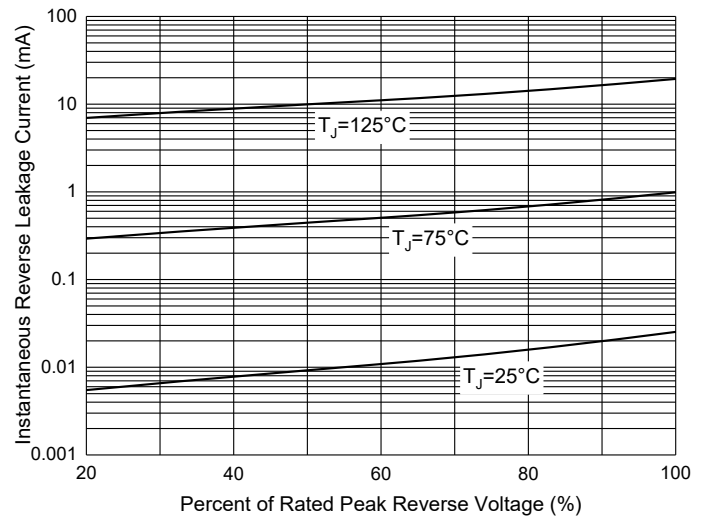
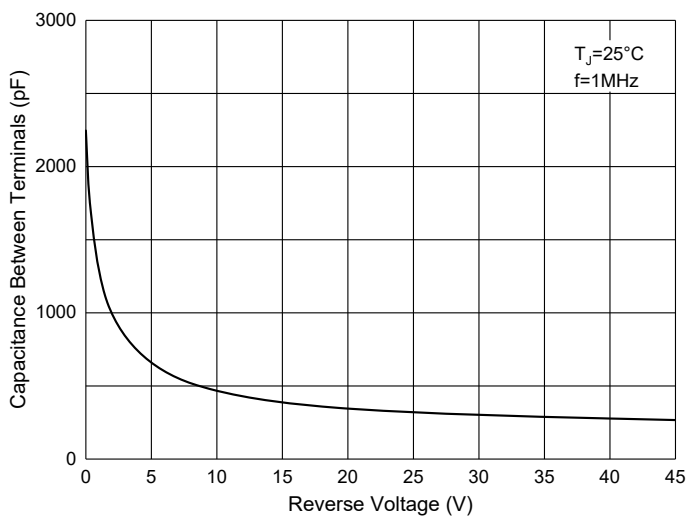

Fig. 5 - Typical Capacitance Characteristics



Ordering Information

Device	Packing
SK1545-LTP	Tape&Reel: 3Kpcs/Reel

IMPORTANT NOTICE

Micro Commercial Components Corp. reserves the right to make changes without further notice to any product herein to make corrections, modifications, enhancements, improvements, or other changes. **Micro Commercial Components Corp.** does not assume any liability arising out of the application or use of any product described herein; neither does it convey any license under its patent rights, nor the rights of others. The user of products in such applications shall assume all risks of such use and will agree to hold **Micro Commercial Components Corp.** and all the companies whose products are represented on our website, harmless against all damages. **Micro Commercial Components Corp.** products are sold subject to the general terms and conditions of commercial sale, as published at <https://www.mccsemi.com/Home/TermsAndConditions>.

LIFE SUPPORT

MCC's products are not authorized for use as critical components in life support devices or systems without the express written approval of Micro Commercial Components Corporation.

CUSTOMER AWARENESS

Counterfeiting of semiconductor parts is a growing problem in the industry. Micro Commercial Components (MCC) is taking strong measures to protect ourselves and our customers from the proliferation of counterfeit parts. MCC strongly encourages customers to purchase MCC parts either directly from MCC or from Authorized MCC Distributors who are listed by country on our web page cited below. Products customers buy either from MCC directly or from Authorized MCC Distributors are genuine parts, have full traceability, meet MCC's quality standards for handling and storage. **MCC will not provide any warranty coverage or other assistance for parts bought from Unauthorized Sources.** MCC is committed to combat this global problem and encourage our customers to do their part in stopping this practice by buying direct or from authorized distributors.